

SAMSUNG

**Product
Catalogue**
Eco Heating System

2022/23

Highlights for 2022/2023

EHS Mono HT Quiet

Samsung introduces its Eco Heating System (EHS) Mono High Temperature (HT) Quiet with the aim to service the growing renovations market and expand the offer for new buildings.

This premium heating solution seamlessly integrates while adding style and elegance to a multitude of exterior facades from renovation builds to luxury homes. Additionally it provides an added sense of ease and comfort for consumers and home owners as it meets all heating needs of a household while quietly operating in the background.

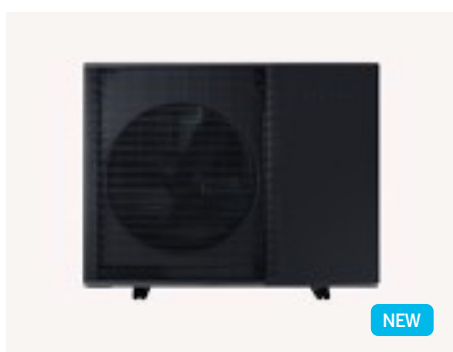

EHS Mono HT Quiet



Hot Water



Low Noise



SmartThings



Energy Usage



- Advanced features to achieve hot water temperature of 70°C¹.
- Enlarged Heat Transfer Area by approximately 11.9% larger².
- New scroll compressor.
- The EHS Mono HT Quiet operates quietly with noise levels as low as 35 dB(A) using a 4-step Quiet Mode³.
- The Samsung EHS Mono HT Quiet has a SCOP* of A+++ energy efficiency rating therefore it is proven to operate with a high level of efficiency.
- Equipped with SmartThings + Wi-Fi 2.0⁴.
- The Quiet Mark is applicable for UK & EU territories only.

¹Leaving water temperature, when the outdoor temperature is between -15°C – 43°C. Results may vary depending on the actual usage conditions

²Based on Samsung's measurements on an EHS Mono HT Quiet (AE120BXYDGG/EU) model compared to a conventional outdoor unit (AE120RXYDGG/EU) with the same capacity.

³Based on internal testing. The noise level is measured 3m away from the front of the outdoor unit, in an anechoic room with an outside temperature of 7°C. Results may vary depending on environmental factors and individual use.

* SCOP = Seasonal Coefficient of Performance.

⁴Wi-Fi connection and Samsung SmartThings application account are required. Wi-Fi Kit to be ordered separately. Requires iOS 10.0 or later & Android 5.0 or later.

ClimateHub

The Samsung EHS (Eco Heating System) extends the compact and modular Tank Integrated Hydro Unit for TDM Plus in addition to Mono and Split. With the ClimateHub Tank integrated Hydro Unit, you can save both space and installation time. Its 2-zone control and advanced functions enable optimal energy efficiency and performance.



ClimateHub



Floor heating



Radiator



Hot water



Quiet operation



Smooth installation



Wi-Fi Control (optional)

- Compact unit size with large water tank (200 L and 260 L).
- Intuitive, colour screen touch controller in multiple languages¹.
- Energy monitoring through touch controller.
- 2-zone control, suitable for floor heating and radiators.
- SmartThings compatible with optional Wi-Fi kit².
- Backup heater is included to ensure continuous heating.
- Solar Power (PV) and Smart Grid ready.
- Smooth servicing through the front-mounted service window.

¹ Available languages: English, German, Spanish, French, Italian, Polish, Portuguese, Dutch, Greek, Czech, Slovak, Finnish, Swedish, Norwegian, Danish and Lithuanian.

² A Wi-Fi connection and Samsung SmartThings application account are required. Wi-Fi Kit to be ordered separately. Requires iOS 10.0 or later & Android 5.0 or later.

SmartThings



The SmartThings App can make any home a Smart Home with a simple click. The SmartThings App provides connectivity with the EHS heat pumps, WindFree™ air conditioners and Samsung audio / video appliances and devices through home Wi-Fi.

The optional Wi-Fi Kit allows control of the EHS and optional air conditioning indoor units via smartphone with the Samsung SmartThings app¹. The app lets you monitor, track and manage how and when compatible Samsung appliances and air conditioners perform their tasks.

With the Bixby 2.0 Artificial Intelligence (AI) system¹, user voice commands² can be carried out by the device. It even analyses the environment, preferred mode, temperature and suggests the best settings enabling optimal indoor climate³.

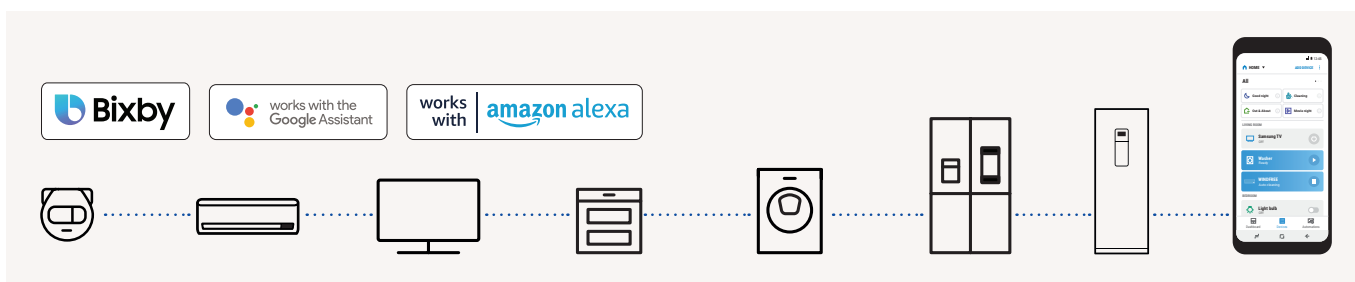

¹ A Wi-Fi connection and Samsung SmartThings application account are required. Wi-Fi Kit to be ordered separately. Requires iOS 10.0 or later & Android 5.0 or later.

² Currently Voice control is supported in English (US, UK, Indian), Chinese, Korean, French, German, Italian, Spanish and Portuguese.

³ Voice control is supported by AI speakers such as Samsung Bixby 2.0, Google Assistant (Google Home) and Amazon Alexa. Google Assistant is not available in certain languages and countries. Google is a trademark of Google LLC.

EHS Selections Software

Samsung EHS Selection Software* is an advanced design automation program that helps you design your heating system more easily and precisely.

You can select the most suitable heating system from the entire range of Samsung EHS products and design the system with its user-friendly interface. It helps to ensure that the system's design complies with Samsung's engineering guidelines.

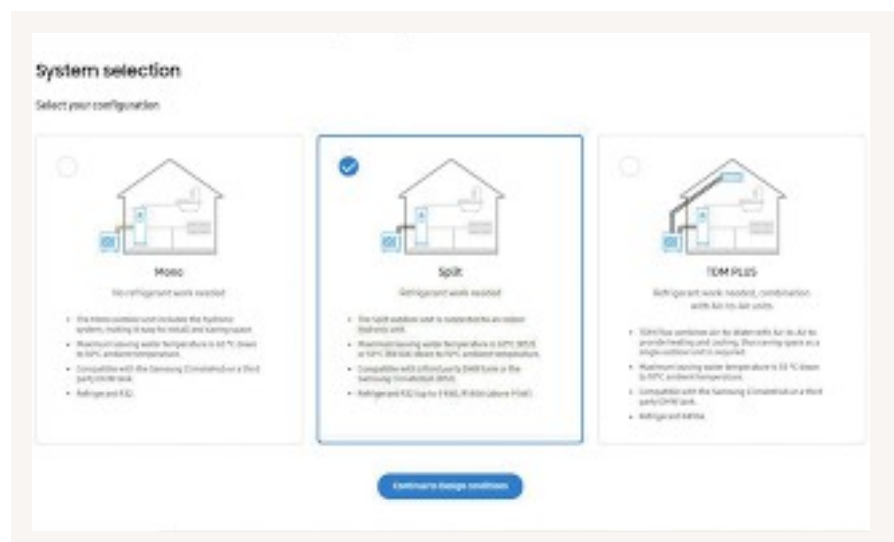

*Available from December 2022 onwards.

Product overview

Mono

The EHS Mono can connect to third party equipment such as a Domestic Hot Water (DHW) tank thanks to the Samsung Mono control kit. The Mono Control kit includes a controller, flow sensor, DHW sensor and leaving and return water sensors.

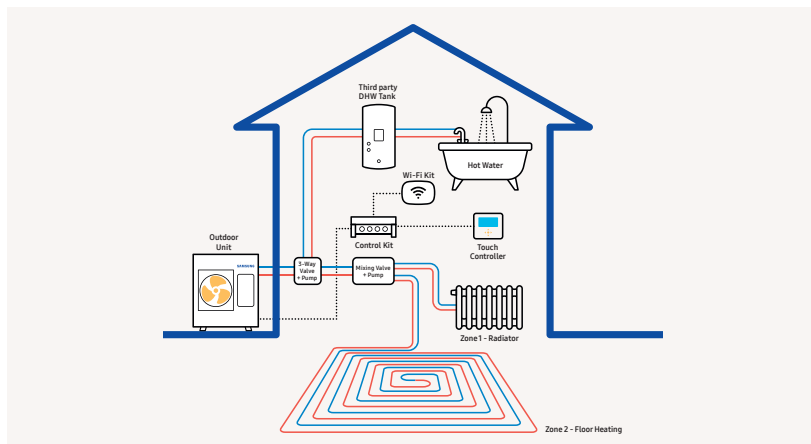

Split

The EHS Split outdoor unit is connected to a wall-mounted Hydro Unit to combine with a third party Domestic Hot Water (DHW) tank to suit all requirements. When used with the Hydro Unit, the Split enables production of domestic hot water and underfloor heating/cooling, and heating of radiators.

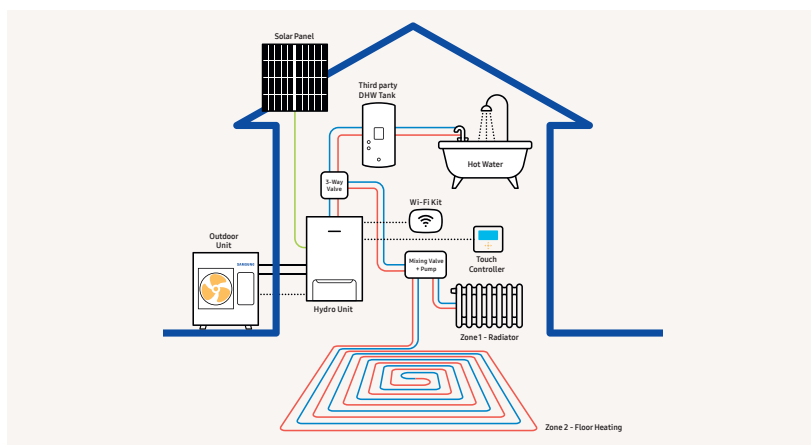





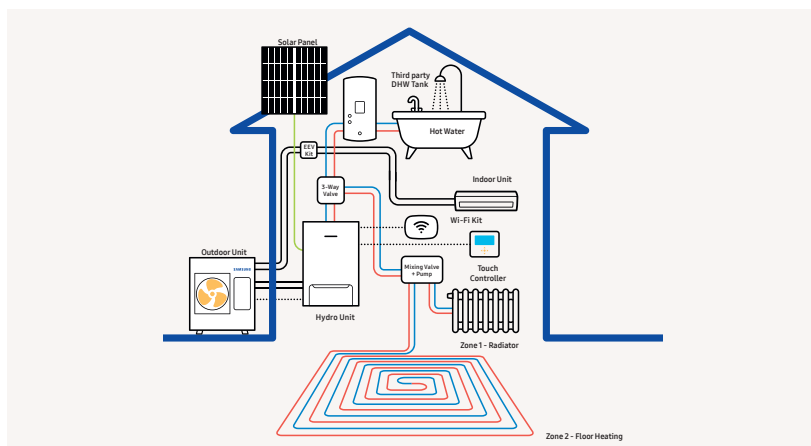





















TDM Plus













The EHS TDM Plus outdoor unit can connect to a third party Domestic Hot Water Tank (DHW) via a wall-mounted Hydro Unit. TDM Plus offers A2W and A2A home climate comfort.

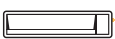

Schematic drawings are for illustrative purposes only. For accurate installation information please consult the technical data book. The selection of the exact product is subject to specific application conditions. Solar panels, underfloor heating panels, radiators and non-integrated components are not provided by Samsung unless specified otherwise. For more detailed product information and technical specifications, please consult the respective product pages of this Product Catalogue.

Indoor Units			Available Samsung product range			Controls		
								
Tank Integrated Hydro Unit	Wall-Mounted Hydro Unit	Third party DHW Tank	R32	Wireless	Wired	Centralised		
								
Wall-Mounted	Duct	Console	R410A	Mono Control Kit	Wi-Fi Kit			

Indoor Units			Available Samsung product range			Controls		
								
Tank Integrated Hydro Unit	Wall-Mounted Hydro Unit	Third party DHW Tank	R32	Wireless	Wired	Centralised		
								
Wall-Mounted	Duct	Console	R410A	Mono Control Kit	Wi-Fi Kit			

Indoor Units			Available Samsung product range			Controls		
								
Tank Integrated Hydro Unit	Wall-Mounted Hydro Unit	Third party DHW Tank	R32	Wireless	Wired	Centralised		
								
Wall-Mounted	Duct	Console	R410A	Mono Control Kit	Wi-Fi Kit			

Product overview

ClimateHub Mono

The ClimateHub Mono configuration has a single outdoor unit that includes the hydronic system, making it easy to install and use. The system's potential can be maximised by connecting to Smart Grid or Solar Power (PV).

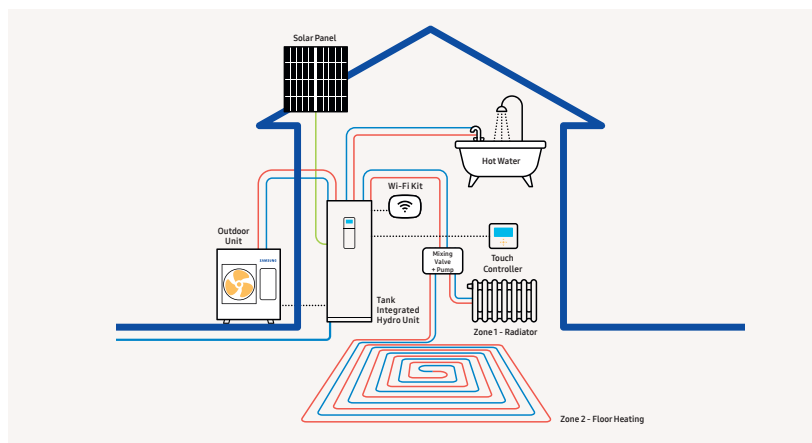

ClimateHub Split

The ClimateHub Split configuration has a single outdoor unit, connected by refrigerant pipes to the tank integrated hydro unit. To maximise its potential, the system can be connected to Smart Grid or Solar Power (PV).

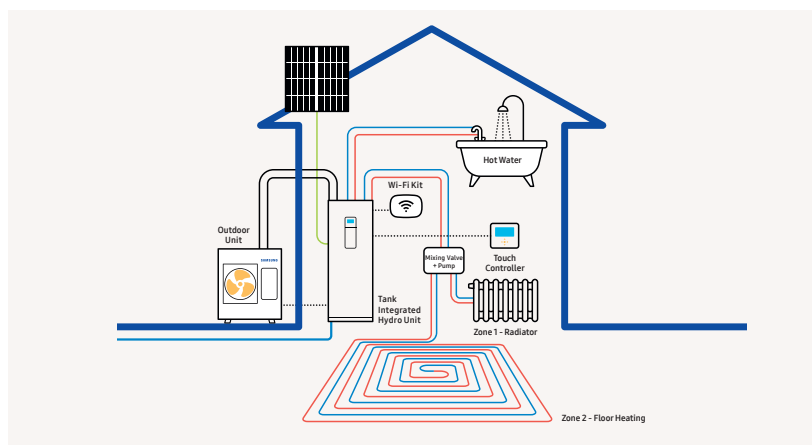





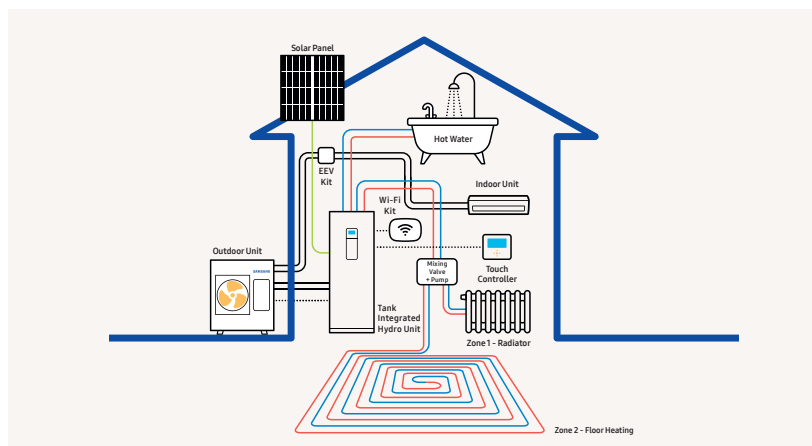



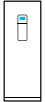













ClimateHub TDM Plus









The TDM Plus system is an 'All-In-One' Air-to-Water (A2W) and Air-to-Air (A2A) system for a complete home climate solution. It can be used throughout the year for cooling and heating to meet a variety of different user situations and needs. It enables underfloor heating/cooling and radiator heating, as well as offering A2A cooling support with various options for air conditioning. The system's potential can be maximised by connecting to Smart Grid or Solar Power (PV).



Schematic drawings are for illustrative purposes only. For accurate installation information please consult the technical data book. The selection of the exact product is subject to specific application conditions. Solar panels, underfloor heating panels, radiators and non-integrated components are not provided by Samsung unless specified otherwise. For more detailed product information and technical specifications, please consult the respective product pages of this Product Catalogue.

Indoor Units			Available Samsung product range			
			Outdoor Units	Controls		
 Tank Integrated Hydro Unit	 Wall-Mounted Hydro Unit	 Third party DHW Tank	 R32	 Wireless	 Wired	 Centralised
 Wall-Mounted	 Duct	 Console	 R410A	 Mono Control Kit	 Wi-Fi Kit	

Indoor Units			Available Samsung product range			
			Outdoor Units	Controls		
 Tank Integrated Hydro Unit	 Wall-Mounted Hydro Unit	 Third party DHW Tank	 R32	 Wireless	 Wired	 Centralised
 Wall-Mounted	 Duct	 Console	 R410A	 Mono Control Kit	 Wi-Fi Kit	

Indoor Units			Available Samsung product range			
			Outdoor Units	Controls		
 Tank Integrated Hydro Unit	 Wall-Mounted Hydro Unit	 Third party DHW Tank	 R32	 Wireless	 Wired	 Centralised
 Wall-Mounted	 Duct	 Console	 R410A	 Mono Control Kit	 Wi-Fi Kit	



Project: Casa L (Spain)
Project Architecture: ABATON
Interior Design: BATAVIA
Photography: Carlos Muntadas

Table of contents

Introduction

Samsung Climate Solutions at a glance
Reference projects in the spotlight
Regulations and Standards
Certifications

Innovations in detail

Eco Heating System (EHS)
EHS Mono & Split
ClimateHub
TDM Plus
TDM Plus Duct
TDM Plus Console
EHS Mono HT Quiet **NEW**
Wall-mounted Hydro Unit
DVM Hydro Unit
SmartThings

Eco Heating System (EHS)

Product Line-up
Selecting the right heating system
Nomenclature
ClimateHub Features

Mono

ClimateHub Mono
Mono with Third Party DHW Tank

Split

ClimateHub Split
Split with Third Party DHW Tank

TDM Plus

ClimateHub TDM Plus
TDM Plus with Third Party DHW Tank
TDM Plus WindFree™ Deluxe
TDM Plus Slim Duct
TDM Plus MSP Duct
TDM Plus Console

Renovation Solutions

EHS Mono HT Quiet **NEW**

Alternative Heating Solutions

DVM S Eco with Hydro HT

Controls

Line-up
Features

Accessories

Line-up

Design and support

Samsung Climate Solutions Partner Portal
Samsung EHS Software Selection **NEW**
Samsung specialist design support
Samsung Climate Solutions Academy
Hydraulic Schematics

Samsung Climate Solutions at a glance

Samsung Climate Solutions aims to help people find their flow, so they may feel and live their best life – be it at work, play or rest. We are committed to offering more energy-efficient solutions with innovative cooling, heating, domestic hot water, refrigeration and smart building solutions. For every space where people create memorable experiences together, be it commercial spaces or residential homes.

We offer:

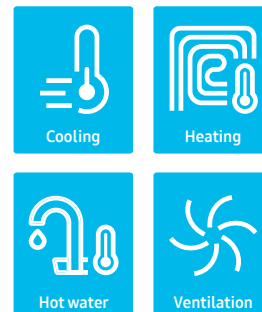

Our market-centric product ranges

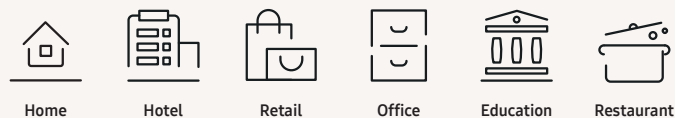

Residential

RAC | FJM

Light Commercial

CAC | FJM

CAC

Commercial

DVM | HVM | ERV | VRF

Heating

EHS

Controls

CONTROLS



Services we provide to empower our partners



Corporate and Technology milestones that make us proud

1974

Samsung introduces its first air conditioner.

2005

Samsung Electronics enters the European market for commercial air conditioning.

2017

Samsung Electronics opens Samsung Electronics Air Conditioner Europe B.V. (SEACE) in Amsterdam.

2014

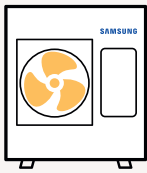

Arrival of the Samsung TDM concept, an all-in-one heat pump solution for heating, cooling and domestic hot water supply.

2015



Introduction of the Samsung 360 Cassette, the world's first circular air conditioner that fits seamlessly into the design of any space.

2017

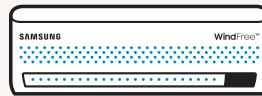

Samsung WindFree™ technology comes onto the market, gently and evenly dispersing fresh air through thousands of micro-holes to limit cold drafts.

2021

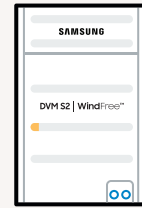

Samsung launches the sixth generation of its Digital Variable Multi the DVM S2 equipped with AI technology, enhanced energy efficiency performance, easier installation and serviceability.



Our flagship innovations that enrich people's lives

Our European footprint with the locations from which we operate

- 1 | Samsung Electronics Air Conditioner Europe B.V.
- 16 | Samsung offices
- 8 | Warehouses
- 9 | Training centres



Samsung reference projects in the spotlight

Furlan Costruzioni





Marco Furlan

Founder
Furlan Costruzioni

"Furlan Costruzioni has realised high-efficiency buildings over the past 50 years, using premium materials and the most advanced technological solutions. For our CasaZero project, the goal was to achieve zero-impact emissions by implementing renewable energy solutions when constructing the buildings. We chose the Samsung TDM Plus heat pump system for its innovative features, high efficiency and flexibility. With just one outdoor unit it manages Air-to-Air indoor units, floor heating and domestic hot water, saving both space and cost. With the TDM Plus system we have realised apartments that solely use electricity and removed the need for a gas boiler for domestic hot water. The efficiency of the apartments is further improved by connecting the system to photovoltaic modules. Additionally, all hydraulic and PV components are installed outside to maximise the living space inside the apartment."

Application



Residential

Samsung products installed

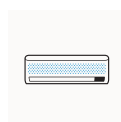

Wall-Mounted

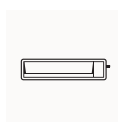

Duct

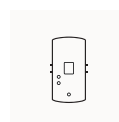

Third Party
DHW Tank

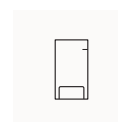

Wall-Mounted
Hydro Unit



EHS TDM Plus
Outdoor Unit R410A

Samsung reference projects in the spotlight

Project Etopia





Joseph Daniels

CEO
Project Etopia Group

“A big step in our Samsung partnership is working collaboratively on the heat pump technology. Through this partnership we are able to provide not only heating, cooling and hot water, but we can do this all whilst utilising renewable energy sources. Our class leading pilot project at the BRE innovation park in Watford, UK, uses this system and has been engineered to be more than energy positive. The real game changer for this product specifically is the ability to intelligently control and harmonise it with our smart home system, providing unseen thermal, energy and environmental control with a positive impact on both cost savings and lifestyle.”

Application



Residential

Samsung products installed

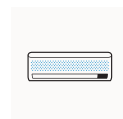

Wall-Mounted



TDM Plus
Outdoor Unit

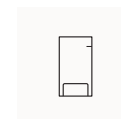

Wall-Mounted
Hydro Unit



SmartThings

Regulations and standards

Samsung strives to provide customers with new eco-friendly experiences and lead the way to a sustainable future for the global community through innovative and eco-friendly products and technology. We monitor applicable environmental standards and laws and regulations in the context of our climate solutions operations. Samsung also conducts environmental improvement activities across all product development, production, distribution, use and disposal phases.

Energy Label

Space heaters, combination heaters, packages of space heater, temperature control and solar device and packages of combination heater, temperature control and solar device are subject to Energy labelling EU Regulation No. 811/2013 and Ecodesign EU Regulation No. 813/2013 requirements.

As of September 2019, the energy efficiency scale for seasonal space heating ranges from A+++ to D, with A+++ being the most efficient. The water heating energy efficiency scale for the declared load profile for combination heat pumps ranges from A+ to F, with A+ being the most efficient.

The energy labels should provide minimum necessary information such as; supplier's name, product model code, the rated output under three European climates (average, colder and warmer) for medium- and/or low-temperature applications (55 °C and 35 °C), European map displaying the three temperature zones, the sound power level indoors and/or outdoors. In addition, just for combination heat pumps, the energy label should also include a pictogram showing to be able to work only during off-peak hours.

Energy Label

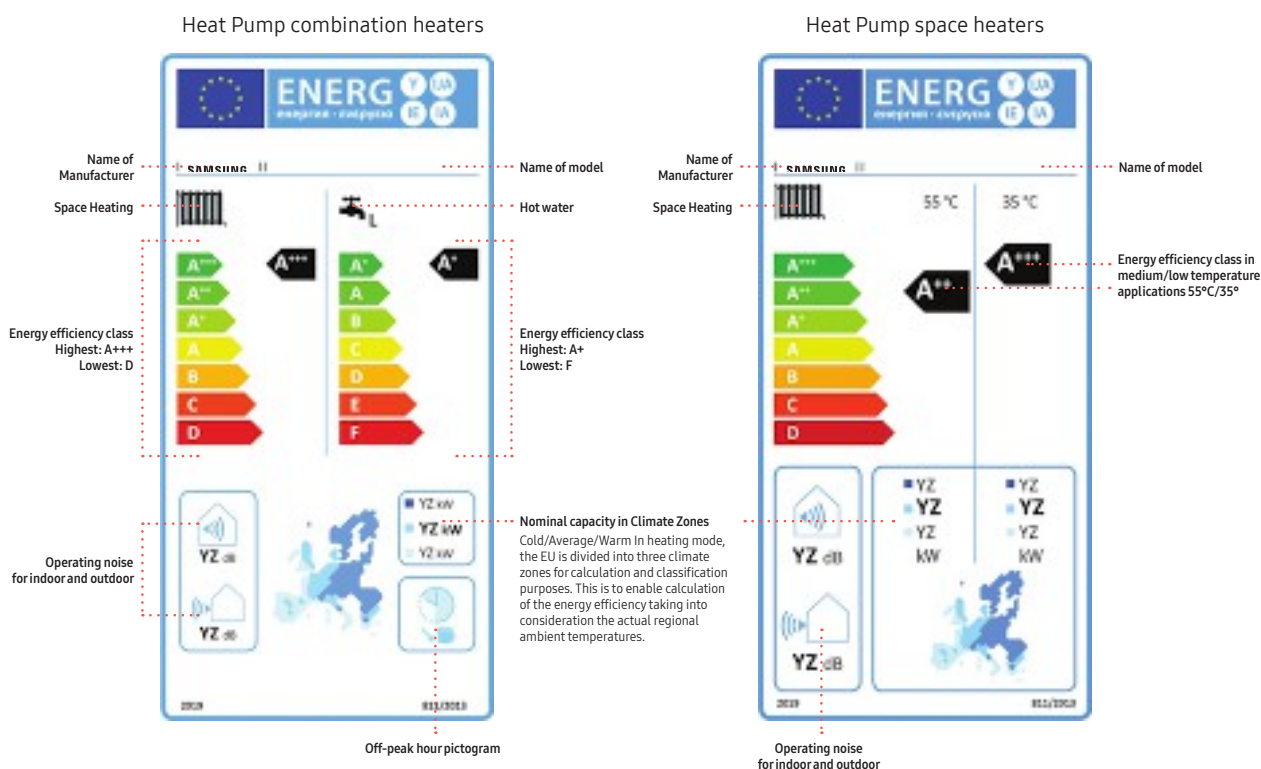

F-Gas regulation

The EU aims to reduce the environmental impact of F-gases through the reduction of the CO₂ equivalent consumption of HFCs (hydrofluorocarbons). EU regulation 517/2014 prescribes a phase-down of HFCs, where the quantities of HFCs that are placed on the market are gradually reduced through the allocation of quotas by the European Commission. The phase-down targets are expressed in CO₂ equivalents (= kg x GWP - Global Warming Potential) and aim to reduce HFC

consumption by 79 % in 2030. For new installations of single split air conditioners with a refrigerant charge below 3 kg, the GWP limit is set at 750 starting in 2025. The regulation has been put into force to encourage the industry and its users to transition to refrigerants with a lower GWP. Samsung is accelerating the transition towards lower GWP refrigerants, such as R32, and will continue to invest in environmentally friendly alternatives.

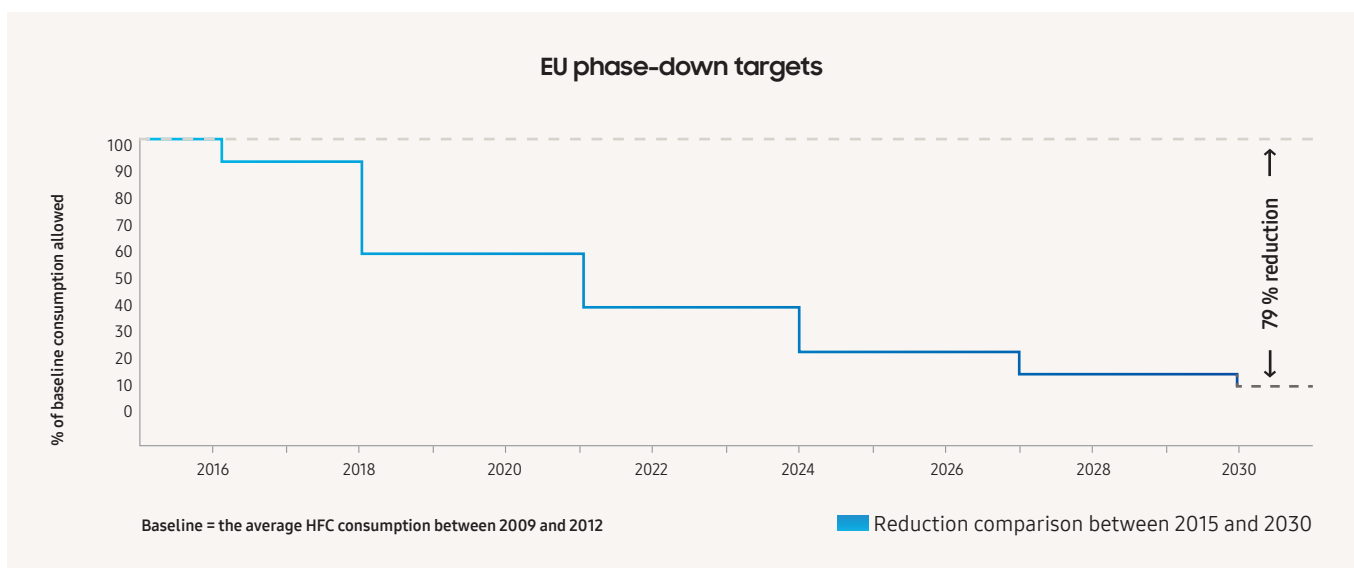

R32 Refrigerant

R32 refrigerant contributes to meeting the F-gas regulation targets as described in EU regulation 517/2014. Air conditioners with R32 refrigerant have a Global Warming Potential (GWP) of 675, which is significantly lower than the GWP of R410A (2,088). While refrigerants are an essential part of today's air conditioners, R32 would have a 68 % lower environmental impact¹ than R410A if leaked into the atmosphere. It has an Ozone Depletion Potential (ODP) of zero, a high refrigeration capacity and a high thermal conductivity; meaning a high efficiency and a reduction in charging volume. Samsung's single split Residential (RAC), Multi Split (FJM) and Commercial (CAC) product ranges up to 12 kW all feature R32 refrigerant.

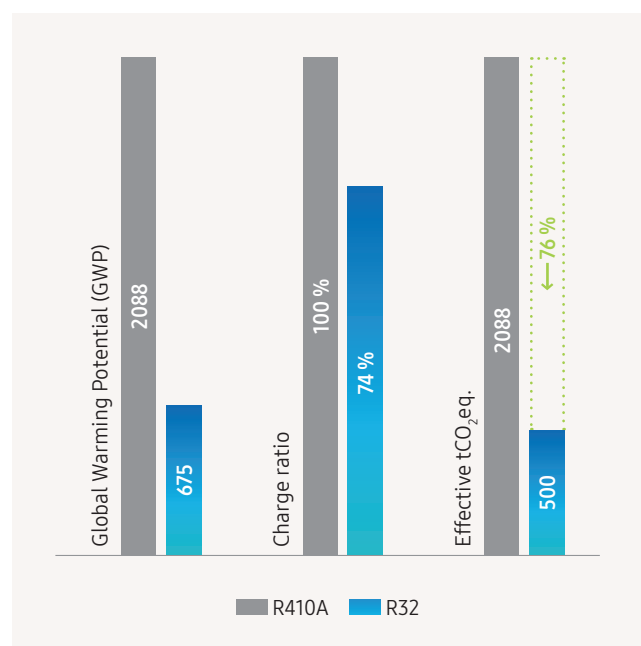

¹ Comparison between R410A and R32 GWP. Source: European Commission.



WEEE: Electronic Waste

Samsung adheres to the WEEE (Waste Electrical and Electronic Equipment) Directive. This Directive applies to the principles of extended producer responsibility. It stipulates the safe collection, treatment, recycling and environmentally sound disposal of all electrical and electronic equipment. By working with collective recycling schemes in each EU member state Samsung co-finances the take-back and recycling of electronic products.

Batteries

Samsung has been giving new life to used batteries by funding collection, treatment and recycling by local battery recycling organisations.

Packaging

Samsung works together with recycling schemes and governmental organisations to collect, separate and reuse all packaging materials at various points in the distribution chain. Many materials can be recycled into new products and recycling helps to save natural resources. Recycling packaging helps to reuse valuable raw materials and to reduce the overall impact on the environment.





Certifications

Heat Pump KEYMARK Certificate

The Heat Pump KEYMARK is a voluntary, independent, European certification mark (ISO type 5 certification) for all heat pumps, combination heat pumps and hot water heaters (as covered by Ecodesign, EU Regulation 813/2013 and 814/2013). It is based on independent, third-party testing and demonstrates compliance with product requirements as set in the Heat Pump KEYMARK scheme rules and with efficiency requirements as set by Ecodesign. It is aimed at certifying the product performances declared by the manufacturers.

The Heat Pump KEYMARK scheme is owned by the European Committee for standardization (CEN). The certificates are granted by independent certification bodies to products fulfilling all requirements of the scheme.

Samsung's Eco Heating Systems and the ClimateHub range are certified with a Heat Pump KEYMARK. This certification is recognised in a number of European countries which include France, Germany, the United Kingdom, Slovakia and Czech Republic.



Eurovent Certificate

Eurovent is globally known for its quality mark 'Eurovent Certified Performance' which certifies performance ratings of air-conditioning and refrigeration products according to European and international standards. The 'Eurovent Certified Performance' mark indicates that the prescribed quality requirement has been fulfilled and should not require the need to be proven after the customer's decision and after the manufacturer's production process.

Eurovent is an accredited third-party certification body. It builds customer confidence by leveling the competitive playing field for all manufacturers and by increasing the integrity and accuracy of the industrial performance ratings. Thus providing trustworthy services to the entire ecosystem.

Samsung air conditioning products ranging from the Residential Air-Conditioning (RAC), Multi Split (FJM), Commercial Air Conditioning (CAC), Digital Variable Multi S (DVM S) and Eco Heating System (EHS) line-up in the 'Air-to-Water' (A2W) heat pump category are all Eurovent certified.

To check the ongoing validity of the Eurovent certified products from Samsung, please visit: www.eurovent-certification.com



Certifications

Quiet Mark Certificate

Quiet Mark is the independent global certification programme associated with the UK Noise Abatement Society charitable foundation (est. 1959). Through scientific testing and assessment Quiet Mark identifies the quietest products in multiple categories spanning many sectors, including: home appliances and technology, building sector materials and commercial sector products.



Quiet Mark certification is the unique consumer and trade champion mark of approval and resource platform. It provides reliable and independent information about the sound a product makes and approved noise reduction performance before purchase with the primary focus to improve health and wellbeing. Stimulating manufacturing worldwide to prioritize responsible acoustic design to reduce noise pollution.

Samsung's Eco Heating System (EHS) Mono High Temperature (HT) Quiet has been certified by Quiet Mark for its low noise. The Quiet Mark is applicable for UK & EU territories only.



Innovations in detail

Eco Heating System (EHS)

Energy Usage

The Samsung EHS includes a range of advanced functions that help optimize energy usage and are independently certified as delivering enhanced energy efficiency as compared to the previous models.

Various Functions for Energy Saving

The 2-Zone Control enables simultaneous heating with two different water temperature demand. The Photovoltaic Enabled feature checks the status of solar panels and adjusts the temperature to reduce network electricity usage. While the Smart Grid Ready feature helps users take advantage of economically efficient and sustainable power supply options.

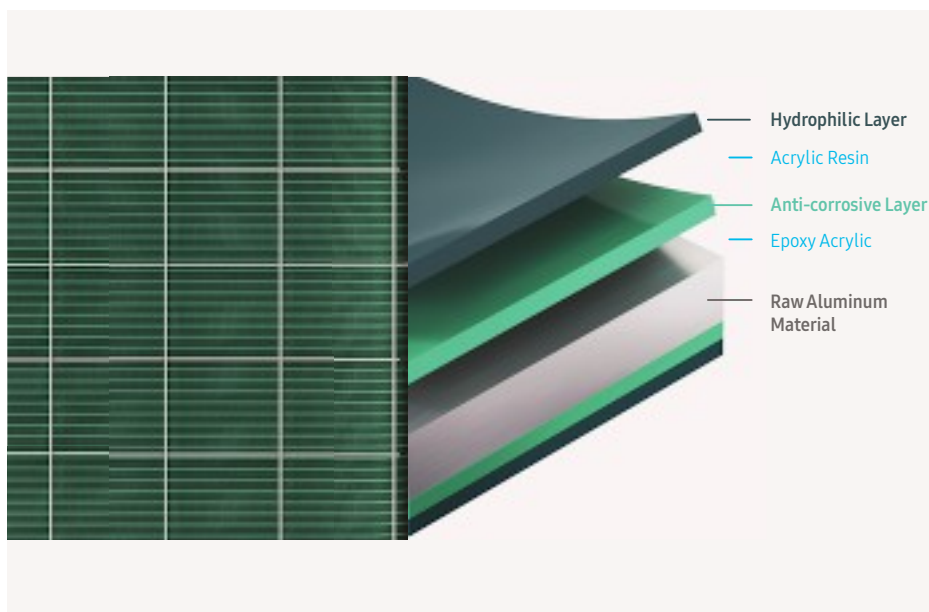

Durafin™ Ultra

The Samsung EHS outdoor unit's Durafin™ Ultra has an anti-corrosive layer of epoxy acrylic and a hydrophilic layer of acrylic resin that disperses water and reinforces its corrosion-resistance. Its improved quality was proven using the Salt Spray Test (SST) over a period of 2,280 hours¹ with no leakage of refrigerant².

¹ Based on testing by a third party lab in accordance with ASTM B117, an official test method. For more details, please contact Samsung's technical professionals.

² Based on testing by a third party lab, applying the actual pressure of refrigerant for 1 minute, after a Salt Spray Test (SST) of over 2,280 hours.

Wide Operation Range

EHS Wall-mounted hydro units can discharge cold and hot water from 5 to 55 °C (leaving water temperature), and the ClimateHub (Tank Integrated Hydro Unit) can store up to 70 °C of water (due to booster heater operation).

EHS TDM Plus Air-to-Air indoor units provide you with a quick individual heating of -25 to 24°C and cooling 10 to 46 °C for each room, as well as Air-to-Water heating of -25 to 35°C and cooling 10 to 43 °C. For EHS Mono & EHS Split with R32 refrigerant there is a higher Leaving Water Temperature (LWT) and with new EHS Mono HT Silent there is a higher Leaving Water Temperature (LWT) at even lower ambient.

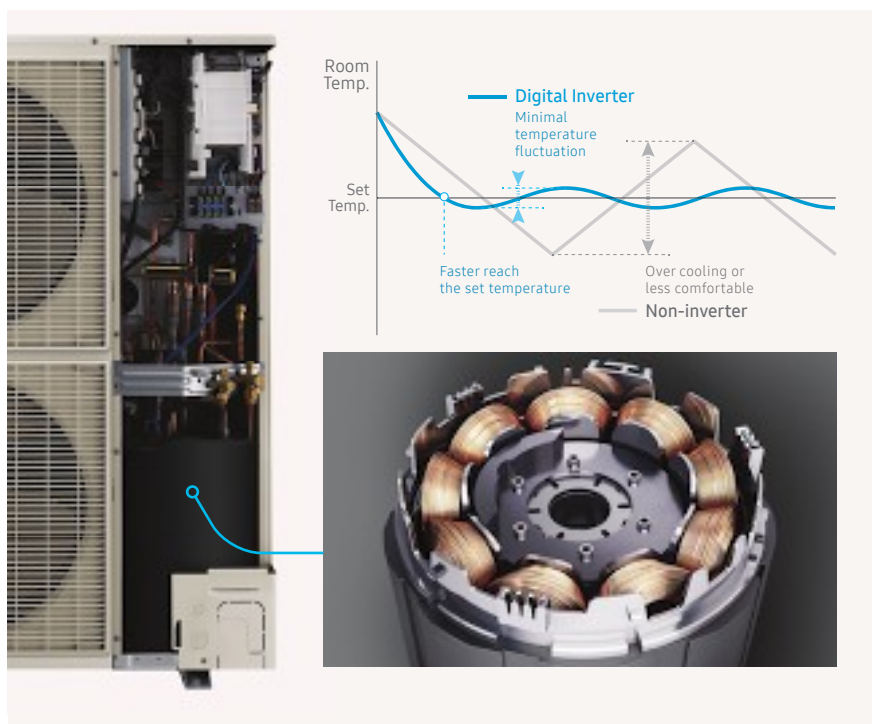
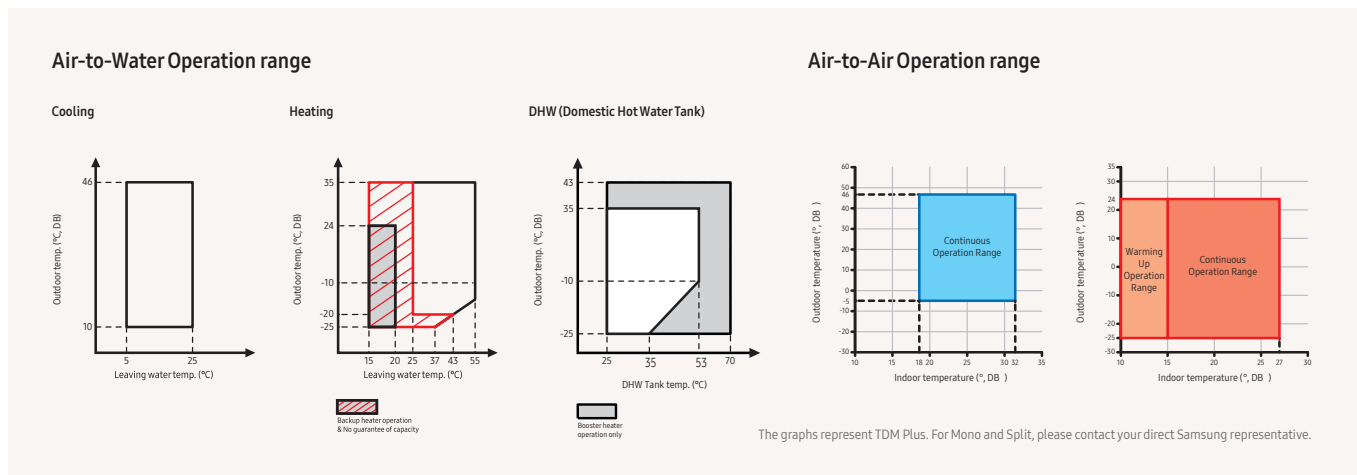

Digital Inverter Technology

Unlike conventional fixed-speed compressors, which frequently shut off and switch on, the compressor automatically adjusts its speed in response to changes in the surrounding room temperature. So it helps to ensure optimum comfort by maintaining the desired temperature with little fluctuation. Additionally, the digital inverter technology optimizes power usage which reduces energy consumption.

Innovations in detail

Eco Heating System (EHS)

Twin Rotary BLDC Compressor

The smart compressor design and premium moving parts of the EHS deliver a balanced performance, fully complying with EU regulations for enhanced efficiency¹.

The Twin Rotary BLDC Compressor of the EHS outdoor unit offers you greater efficiency and reliability. Its twin cams and two balance weights create low levels of vibration, contributing to a smoother and quieter all-round performance. The use of high quality moving parts, such as robust bearings and premium matching rollers and vanes, also ensures much better stability and durability.

¹ All Samsung EHS products comply to EU EcoDesign's Minimum Energy Performance Standards (MEPS).

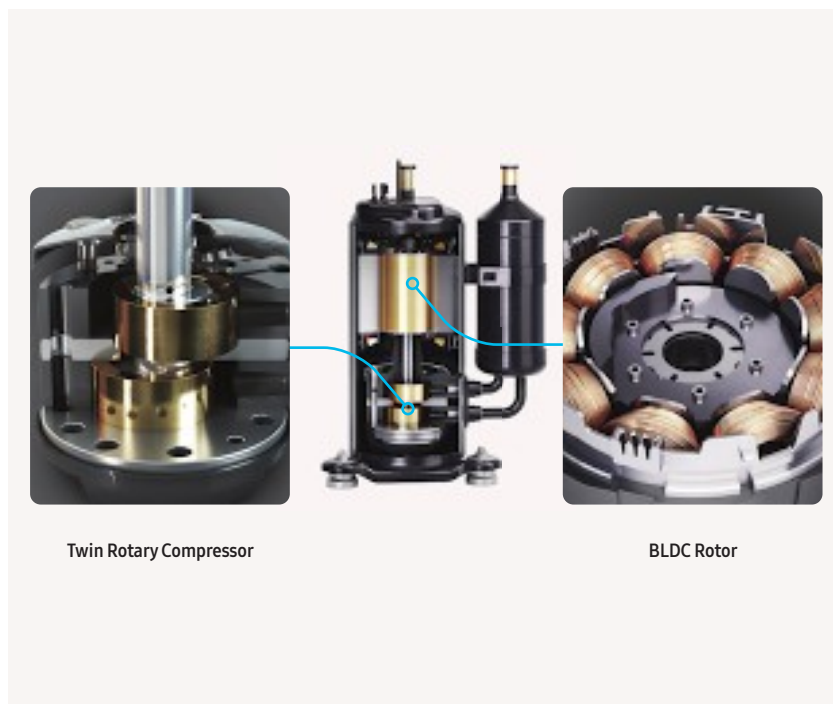

Twin Rotary Compressor

BLDC Rotor

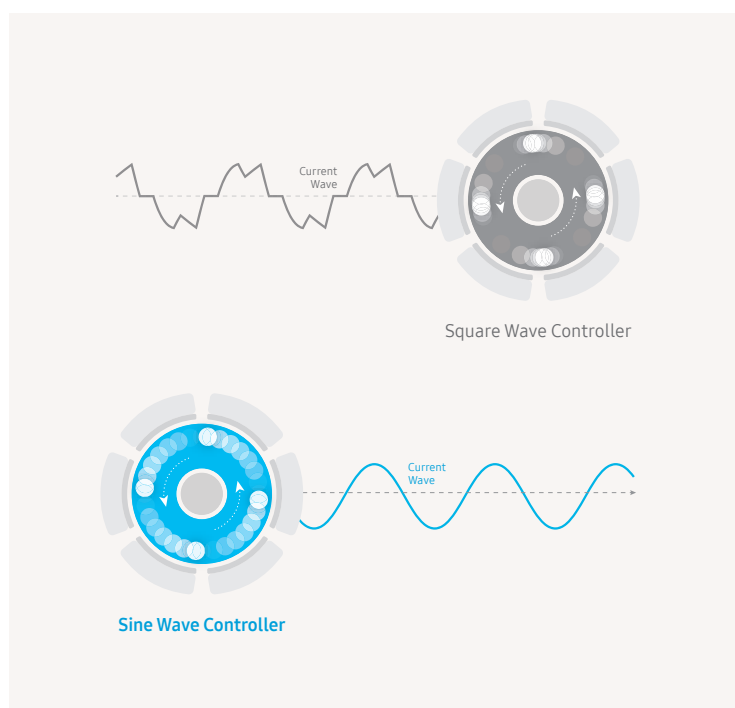

Quieter Current Wave

The combination of superior insulation and low vibration generates less noise, so it creates a comfortable atmosphere. Due to Samsung's newly developed Sine Wave Controller technology you can hear much less noise when the air conditioner is running as compared to previous versions. Unlike a conventional Square Wave Controller, which emits a noticeable sound, it produces current waves that have a smooth curve with no spikes or ripples. This significantly reduces the noise created by the outdoor unit, so it operates very quietly¹ and creates less disturbance.

¹ Based on Samsung's internal test results compared with the Samsung AR09FSSKABENEU model. Individual results may vary.

Double-layered Sound Insulation

The compressor is fully covered in double-layered sound insulation material that absorbs and minimizes noise. When it is applied, the sound becomes about 3 dB(A) quieter¹. So it operates quietly and discreetly, while still delivering high-quality performance.

¹ When testing Split 6 kW and 9 kW models based on internal testing in Samsung Korea. Results may vary depending on environmental factors and individual use.



Anti-Freeze protection control

The Samsung EHS unit which provides the indoors with heating energy is installed outdoors to extract heat from the ambient air. Therefore, whenever the compressor operation is stopped during ambient conditions below 0 °C, the water inside the pipes may freeze and expand, this can damage the water pipes and the components.

In order to prevent this, the Anti-Freeze Protection control function is activated by default. In non-operation mode, if the outside temperature drops to 3 °C or below, the pump on the water pipe side is forcibly operated to prevent freezing in the water pipe. For external water pipes and Anti-Freeze protection feature use propylene glycol with a toxicity rating of Class 1 as listed in Clinical Toxicology of Commercial Products, 5th Edition¹.

¹ Please refer to the installation manual for detailed anti-freeze specifications. Anti-Freeze Protection control should be used only for auxiliary measure in addition to glycol mixture.

Innovations in detail

EHS Mono & Split

Hot water temperature

The EHS Mono & Split can produce hot water of up to 65°C, depending on the ambient air temperature. When the discharge temperature is below 20°C and the outdoor temperature is below 24°C, the Backup Heater is operated to help raise the temperature above a certain level. And, using a Booster Heater, the Tank Integrated Hydro Unit can provide water of up to 70°C.

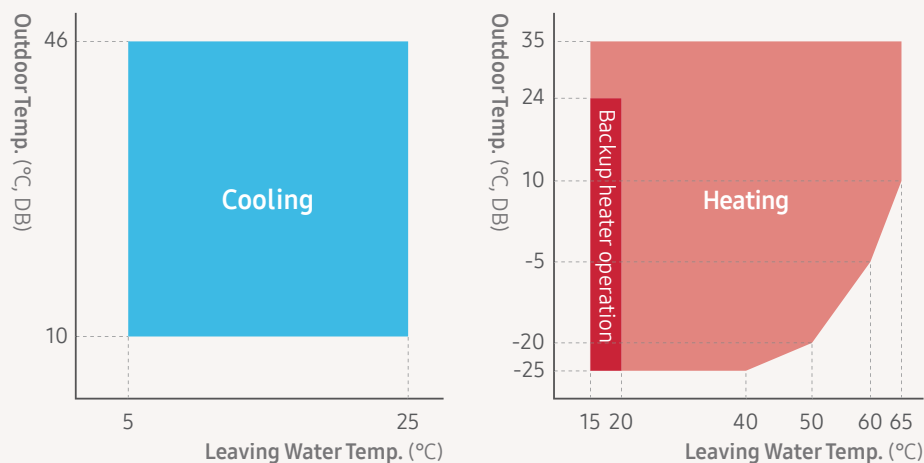

EHS Mono HT Quiet will reach a Leaving water temperature of upto 70°C.

Next Generation of Refrigerant R32

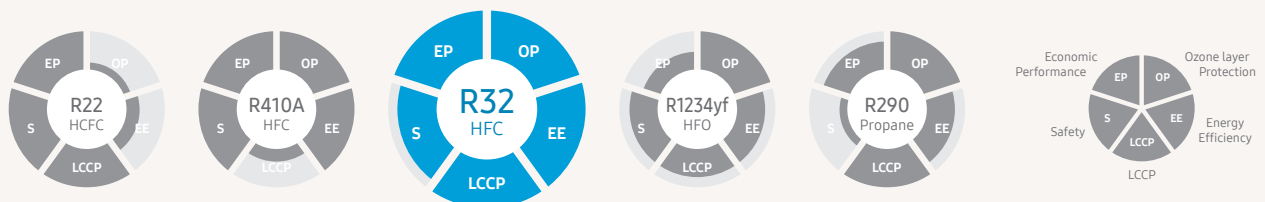

LCCP - Life Cycle Climate Performance

The EHS Mono and Split range uses the next generation of R32 refrigerant, which helps and lower the impact on global warming. It is equipped with an Ozone Depletion Potential (ODP) of zero and a lower Global Warming Potential (GWP) than conventional R22 or R410A refrigerants¹. It also reduces the amount of refrigerant needed and cuts CO₂ emissions², so it's much more environmentally friendly.

¹ GWP rating: R32 refrigerant = 675 vs. R410A refrigerant = 2,088.

² The Samsung EHS Mono and Split (R32) only require 83 % of the refrigerant used in a conventional heating system (R410A) of the same capacity. So the level of CO₂ emissions of the EHS is 560 (675 x 0.83), which is 73% less than the 2,088 produced by a conventional heating system.

Energy Efficiency - SCOP A+++

Our EHS Mono and Split include a range of advanced technologies that help optimise your energy usage. The Samsung EHS has a Seasonal Coefficient of Performance (SCOP) A+++¹ energy efficiency rating, therefore they are proven to operate with a high level of efficiency.

EHS Mono and Split achieve a good heating performance at low temperature by using R32 refrigerant. The R32 refrigerant has a high PdesignH (kW), and works reliably and efficiently even in cold climate.

¹ Air-to-Water Condition : (Heating) Water In/Out 30 °C/35 °C, Outdoor Air 7 °C[DB]/6 °C[WB]; (Cooling) Water In/Out 23 °C/18 °C, Outdoor Air 35 °C[DB].

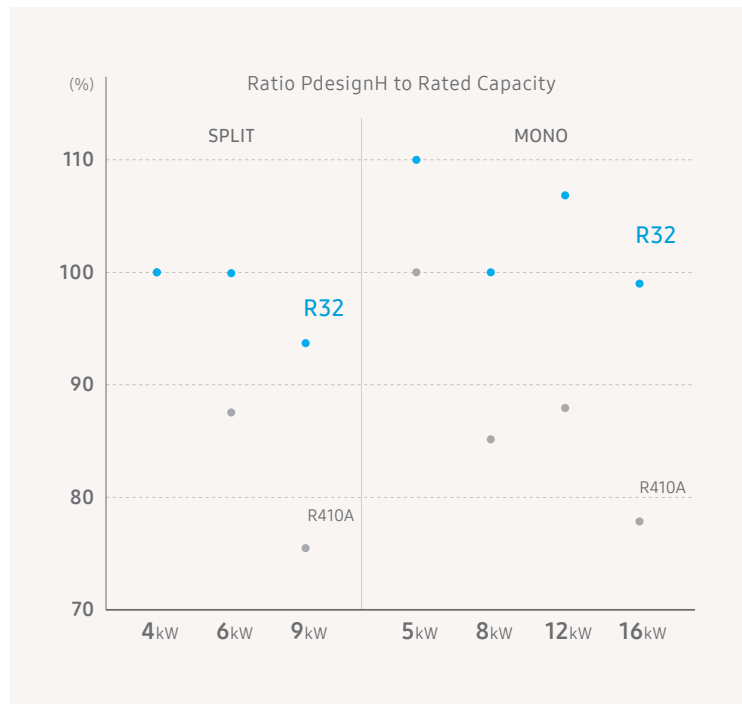

Base Heater

The EHS¹ outdoor unit is specifically designed to provide an optimal performance in extremely cold environments. It features a Base Heater (150W), which improves the defrost operation duration. Therefore contributes in keeping the base plate of the outdoor unit free from ice build-up. Together with the standard feature of snow prevention control, it helps to prevent damage from snow drifts.

¹ Available only in >8kW Mono and >9kW Split model codes

Innovations in detail

EHS Mono

Quiet Operation

The 3-Step Quiet Mode enables adjustable, low-noise operation to meet strict sound level requirements by selecting from three different steps to reduce the sound level by 3dB(A), 5dB(A) or 7dB(A)¹.

¹ Based on internal testing of the EHS Mono outdoor units. The noise level is measured 3m away from the front of the outdoor unit, in an anechoic room with an outside temperature of 7°C. Results may vary depending on the model (capacity), environmental factors and individual use.

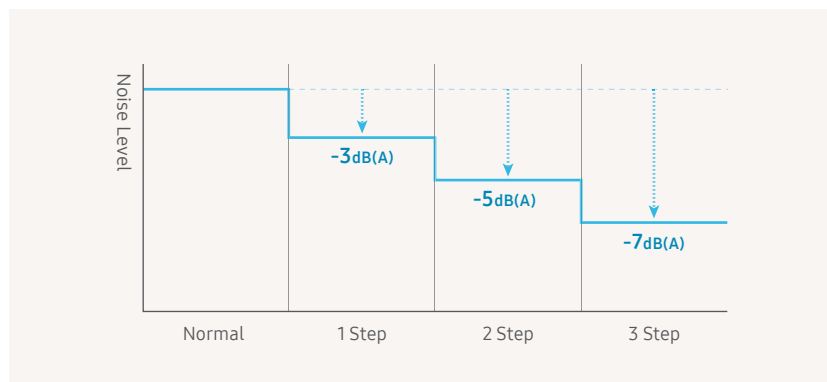

EHS Split

4-way Piping

The EHS Split 4-way piping system¹ has pipe access possibilities at the front, side, bottom and rear, so it provides much more flexibility during installations. It can be configured to suit almost any installation location without additional fittings, while still being discreetly concealed.

¹ Only available on certain models. Contact your local Samsung representative for complete product information.

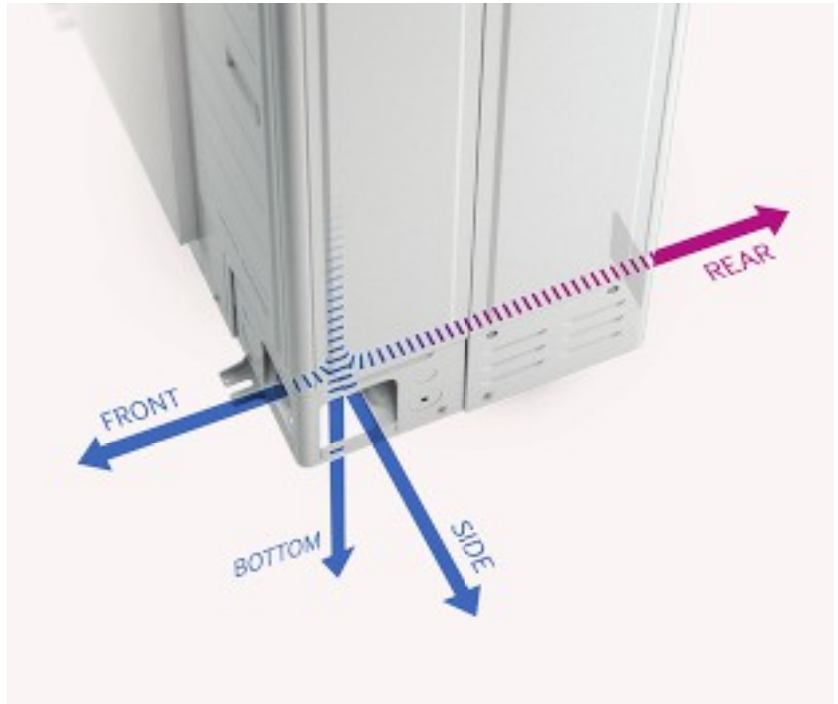

Quiet Operation

The 4-Step Quiet Mode enables adjustable, low-noise operation to meet strict sound level requirements by selecting from three different steps to reduce the sound level by 3dB(A), 5dB(A) or 7dB(A) or keep it as low as 35dB(A)¹.

¹ Based on internal testing of the EHS Split outdoor units. The noise level is measured 3m away from the front of the outdoor unit, in an anechoic room with an outside temperature of 7°C. Results may vary depending on the model (capacity), environmental factors and individual use.

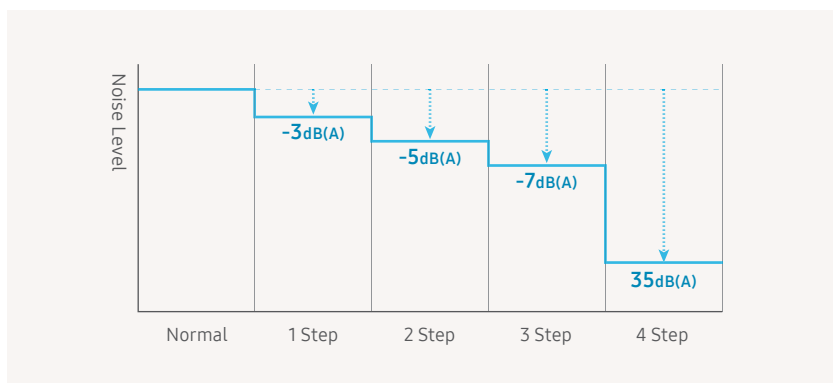





Innovations in detail

ClimateHub

Easy Installation

The compact ClimateHub Mono, Split and TDM Plus are easier to handle and require much less space, so they can be installed in many more places. Additionally they are extremely simple to set up and maintain.



Compact & Integrated Design

A compact and modular Tank Integrated Hydro Unit integrates a conventional hydro unit or control kit, a large hot water tank of either 200 or 260 litres and parts of the water pipes. So it's easier to handle and gives freedom to install it almost anywhere in a building, even in a kitchen or utility room.

Easy Set-up and Servicing

Set up and maintain the ClimateHub system more easily, saving time and effort. With its intuitive servicing options, start-up and maintenance can be done with limited effort through the use of a converter PBA¹ and Micro SD card².

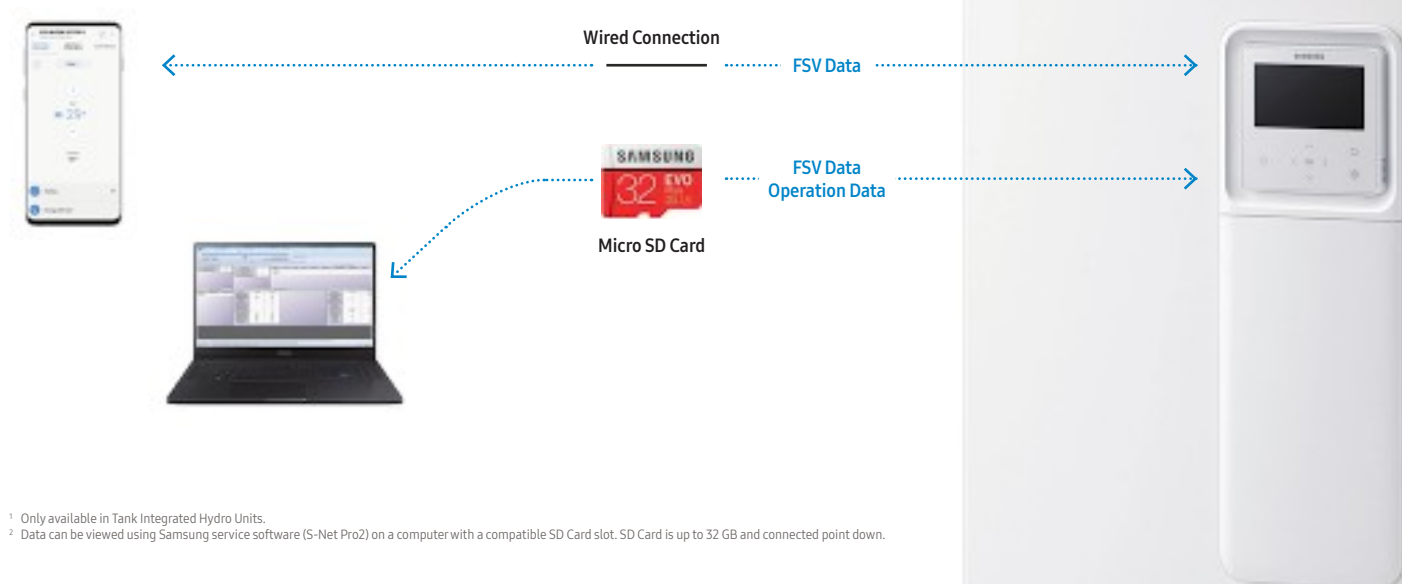

¹ Only available in Tank Integrated Hydro Units.

² Data can be viewed using Samsung service software (S-Net Pro2) on a computer with a compatible SD Card slot. SD Card is up to 32 GB and connected point down.

Convenient Control

The ClimateHub Mono, Split and TDM Plus offer a range of easy to use control options that make life much simpler.

Intuitive Control

The touch controller comes equipped with multiple language options and bright colour display – enabling temperature settings, energy monitoring, summer time setting and quick error monitoring.¹ Different temperatures can be set for each zone, meaning high-temperature radiators and low-temperature floor heating can be utilized efficiently.

¹ The image shows an application example and is for illustrative purposes only. Please always check latest information for understanding availability of language versions. Available in 16 languages: English, German, French, Italian, Spanish, Polish, Portuguese, Dutch, Greek, Czech, Slovak, Finnish, Swedish, Norwegian, Danish, Lithuanian.



Smart Connectivity

With the optional Wi-Fi Kit, up to 16 indoor units can be controlled and monitored through the Samsung SmartThings App.¹

¹ Wi-Fi connection and Samsung SmartThings application account are required. Wi-Fi Kit to be ordered separately. Requires iOS 10.0 or later & Android 5.0 or later.



Quiet Operation

The 4-Step Quiet Mode enables adjustable low-noise operation to meet strict sound level requirements¹. Simply select from four different steps to reduce the sound level by 3 dB(A), 5 dB(A), 7 dB(A)¹ or keep it as low as 35 dB(A)¹.

¹ Based on internal testing of the 6 kW and 9 kW Split outdoor units (AE060RXEDEG, AE090RXEDEG, AE090RXEDGG). The noise level is measured 3 m away from the front of the outdoor unit, in an anechoic room with an outside temperature of 7 °C. Results may vary depending on the model (capacity), environmental factors and individual use. Sound pressure levels are subject to execution and operating conditions.

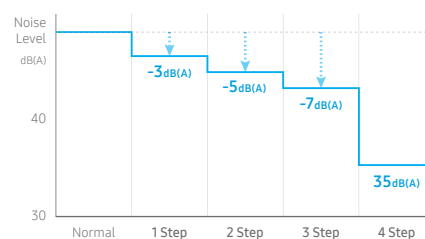

Innovations in detail

A single integrated unit that combines a control kit and a water tank

The Tank Integrated Hydro Unit incorporates a control kit and a large domestic hot water (DHW) tank available in 200 and 260 litre options. Its compact and modular design means that it fits easily into a wide range of locations, as everything is installed in one place. Its intuitive servicing options also ensure that it can be set-up and maintained with minimal effort.

Product Structure

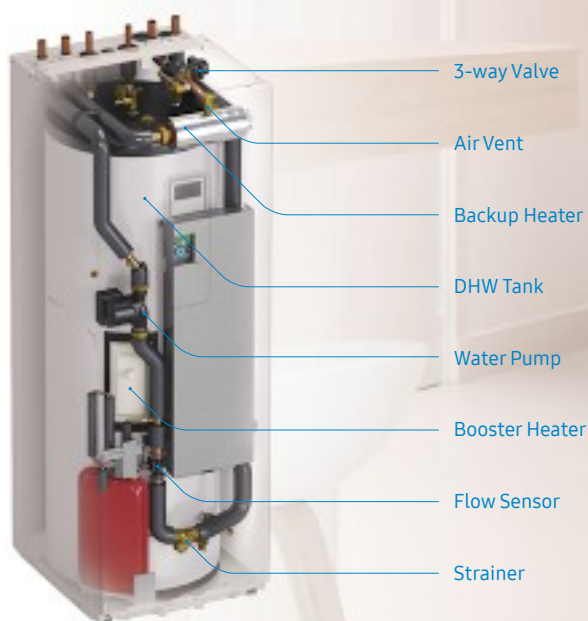

ClimateHub

2-Zone Control

The 2-Zone Control can fulfill two different water temperature demands simultaneously, therefore can optimally heat multiple spaces. This in turn saves energy without heating unused areas unnecessarily.

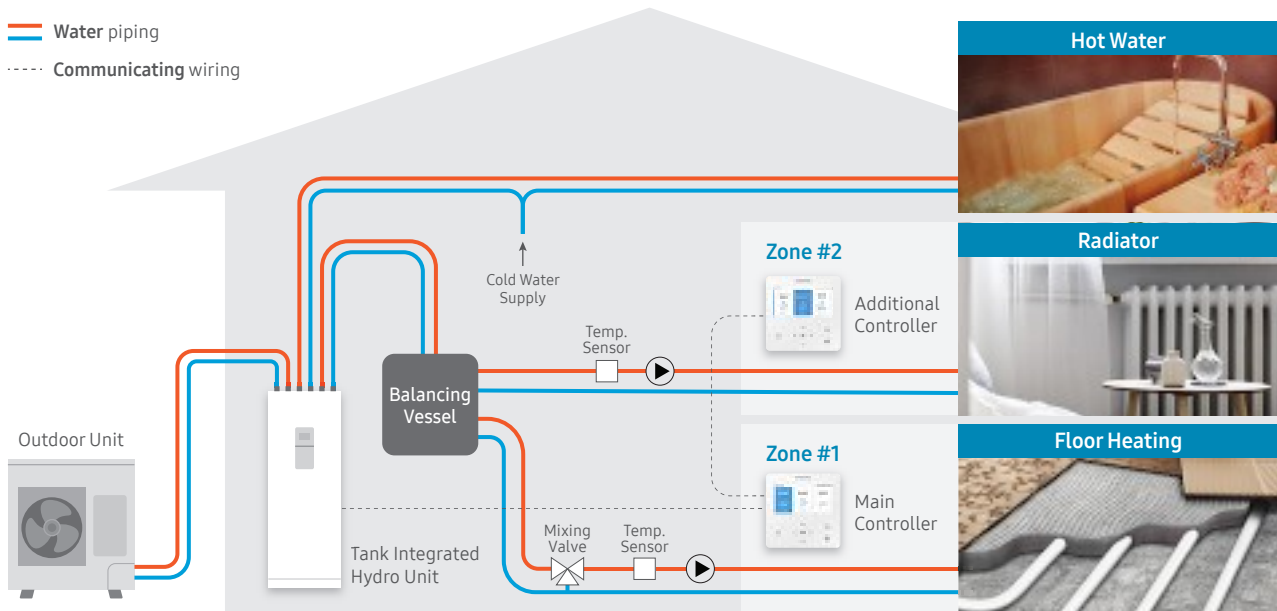

Photovoltaic Enabled

The Photovoltaic Enabled feature checks the status of solar panels and lets you use the solar energy to reduce network electricity usage.

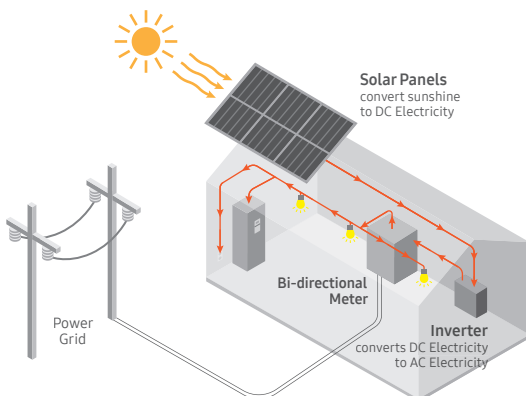

Smart Grid Ready

The Smart Grid Ready feature helps you save energy by adjusting the power consumption to suit your supply contract with the local electric power company.

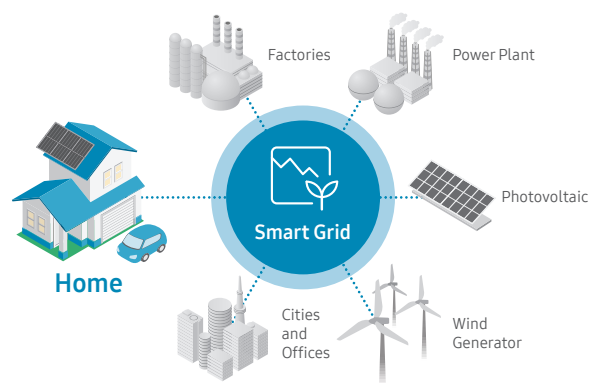

Innovations in detail

ClimateHub

ClimateHub Components

The ClimateHub system includes all the main hydraulic components: therefore making more free space available in your home.

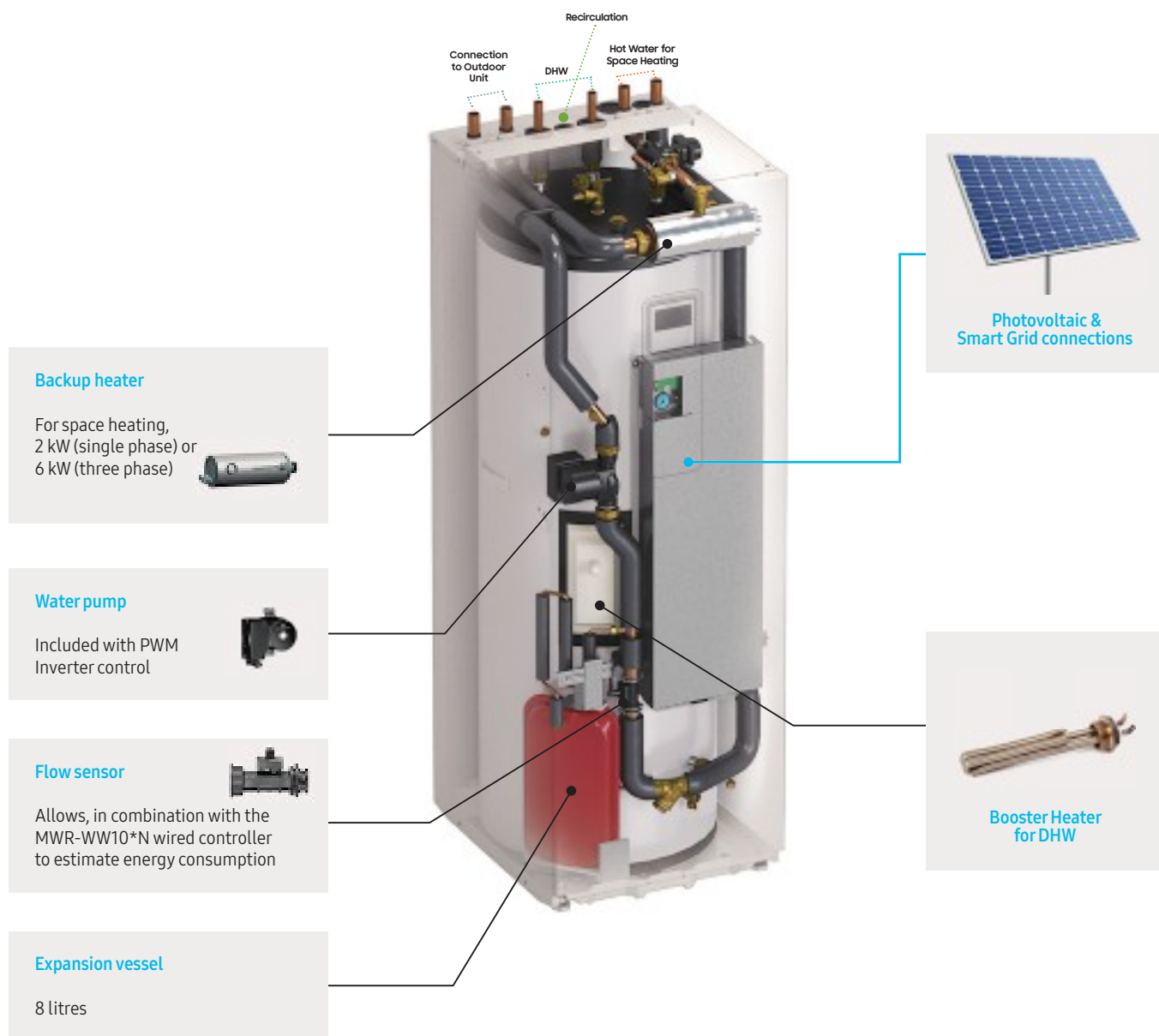

Complete control using MWR-WW10*N

The ClimateHub system controller allows simplified and intuitive management of all settings.

Estimation of consumption:

Measure energy consumed and shown directly on the controller menu.

Automatic temperature adjustment:

Maintaining the requested indoor temperature by automatic adjusting the heating water supply temperature based on the ambient temperature. This feature offers enhanced performance and reduces thermal dispersions and energy waste(2).

Multizone management:

Via this command, it is possible to create and manage two zones with different desired temperatures.

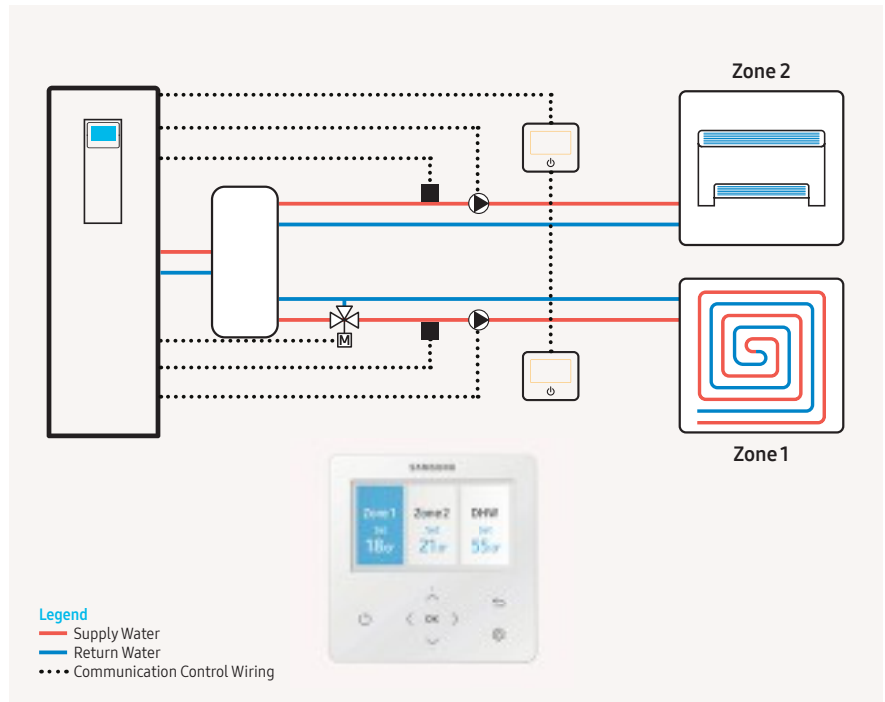

Precise control by using a Flow Sensor

The exchange of thermal energy between the refrigerant and water takes place in the plate heat exchanger. In order to have the most efficient exchange, the EHS can control the flow of water over the plate heat exchanger. A flow sensor¹ is built-in to sense the quantity of water supplied to the plate heat exchanger.

¹ Flow sensor is available in all ClimateHub and 9kW & 16kW Split wall-mounted hydro units.



Innovations in detail

TDM Plus

All-in-one System

The EHS TDM Plus is a one-stop solution that provides hot water to heat radiators, floors and sanitary systems, along with hot or cool air - to create a comfortable environment all year round. As these heating and cooling sources can be operated separately or together, it is suitable for use in a variety of scenarios. So, it can be adapted to suit any specific needs, ensuring maximum comfort and convenience.

ClimateHub
Integrated solution for heating/cooling and domestic hot water supply.



Photovoltaic panel
Can be connected with EHS.



Dispensing hot water
The hot water can be used at any time of the day.

Indoor units
Air-to-Air wall-mounted, console or duct unit for cooling or heating.

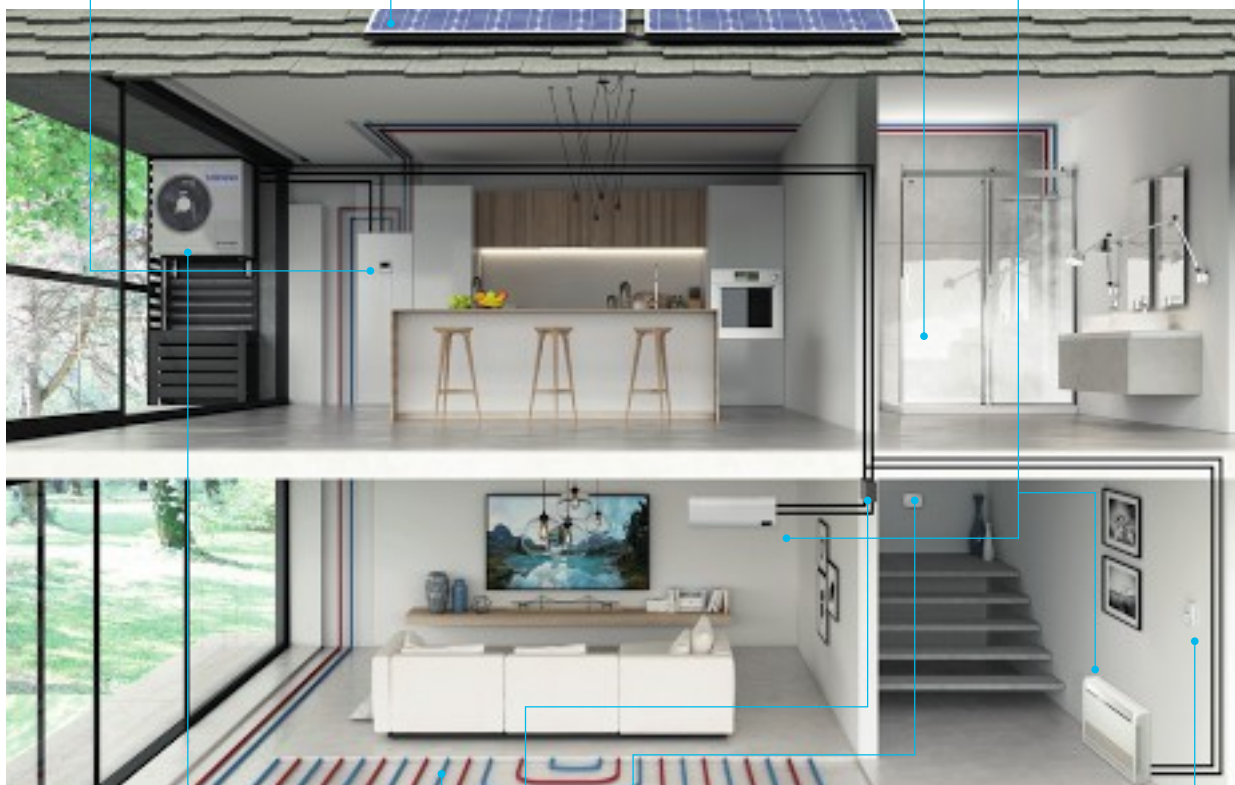

Floor heating / cooling
Hot water circulates in the floor panels heating / cooling the space

Outdoor unit
Offers high performance in all conditions.



Control Panel MWR-WW10*N
Controls ClimateHub



EEV Kit
Possibility to reduce noise (only for interior walls).



Wi-Fi kit
It allows monitoring and management of the system using smartphones remotely with the SmartThings app.



TDM (Time Division Multi) Technology

Samsung's unique TDM technology enables the provision of a total heating and cooling solution, including air-to-water and air-to-air, using only a single outdoor unit. Its smart control of a heat pump system optimally distributes the load and energy to ensure a stable supply of hot sanitary water, while also maintaining a comfortable indoor temperature with its cooling or heating operation.

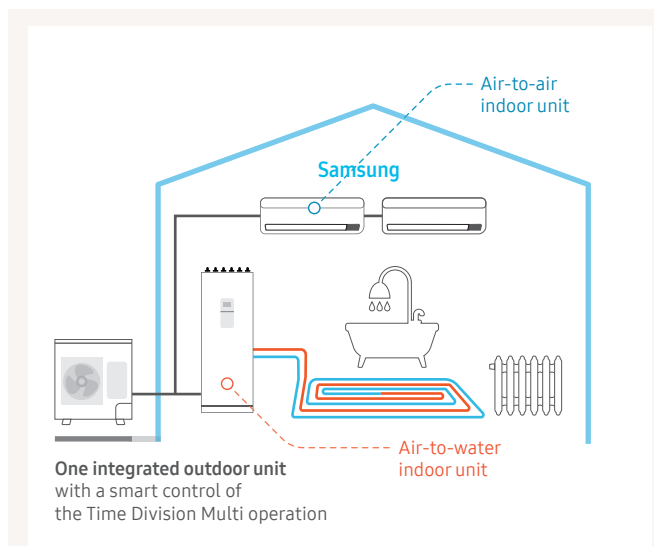

TDM, the patented technology for optimally controlling energy use

The ability to simultaneously provide hot water along with heating and cooling using only one outdoor unit requires a precise heat pump design and an advanced control algorithm. Samsung's TDM technology uses its own algorithm to optimally control the refrigerant and maximize the efficiency of the heat pump system when heating and cooling. These system and algorithm have been patented in many countries, including the US and Europe.

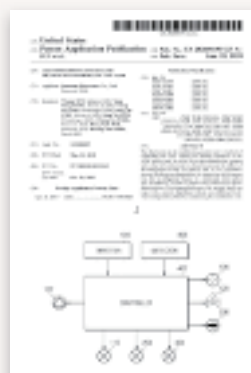

US Patent
US20200191423A1



EU Patent
EP3598015A1

Innovations in detail

TDM Plus

Samsung has developed the innovative TDM Plus technology (Time Division Multi) which allows operation of EHS in Air-to-Water mode and in Air-to-Air mode. The possibility of using the two operating modes allows considerable savings both in economic and installation terms.

TDM Plus system

Legend

Method:

— Heating — Cooling

Air-to-Water cooling and heating

In this mode, the TDM Plus system is usable for the production of domestic hot water and heating of the house through radiators or underfloor heating. Thus the heat pumps allow you to heat the house more quickly by consuming even less energy. The TDM Plus can also supply chilled water for feeding fan coils during the summer period.

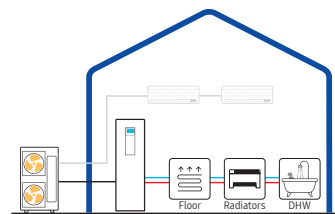

Air-to-Air and Air-to-Water

The greatest advantage of the TDM Plus systems is the combined use of Air-to-Air and Air-to-Water modes for heating and cooling. This means that on the coldest winter days it is possible to heat up the space quickly and easily, before the underfloor heating reaches the desired temperature. (As underfloor heating is quite slow but steady in keeping the room temperature, changes to the set temperature can take relatively long.)

Air-to-Air heating can raise the comfort quickly via heating the air in the room. Both Air-to-Air and Air-to-Water work in the same space to keep the desired room temperature.

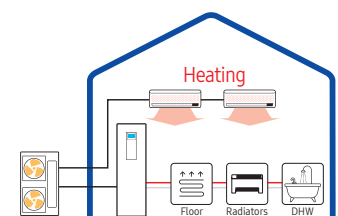

Air-to-Air cooling and heating

An exclusive feature of the TDM Plus systems, in Air-to-Air mode, is that it can operate both in the summer and winter. The cooling phase is also achieved immediately with the Air-to-Air mode. The advantage in the heating mode is the temperature speed control, compared to the use of radiators or fan coil units.

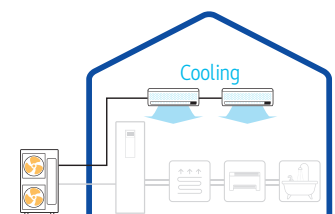

Traditional system

The traditional heat pump system requires two distinct outdoor units for air conditioning and domestic hot water production. Unlike the TDM Plus, the need to use two outdoor units necessarily involves greater electricity consumption and greater installation space.

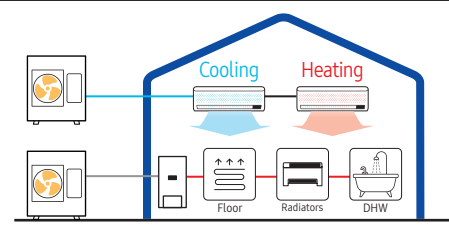

Fast Heating Using TDM Plus technology (Time Division Multi)

Underfloor heating is known to be an optimal system for ideal thermal comfort. It reaches a set temperature 4–8 hours from the moment of its activation. The TDM Plus technology used in the EHS system, also provides for the use of Air-to-Air indoor units, thus drastically reducing the time to reach the desired room temperature.

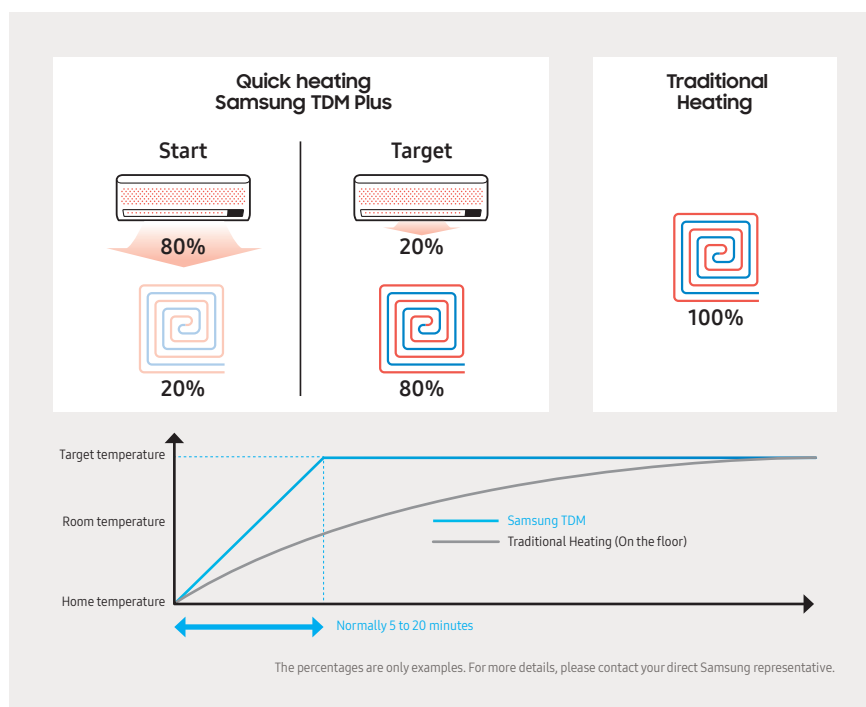

Customizable operation at any time

You can set the priorities and the operating modes for the TDM Plus heat pump using the control unit. You can also adapt the settings or parameters that suit you.

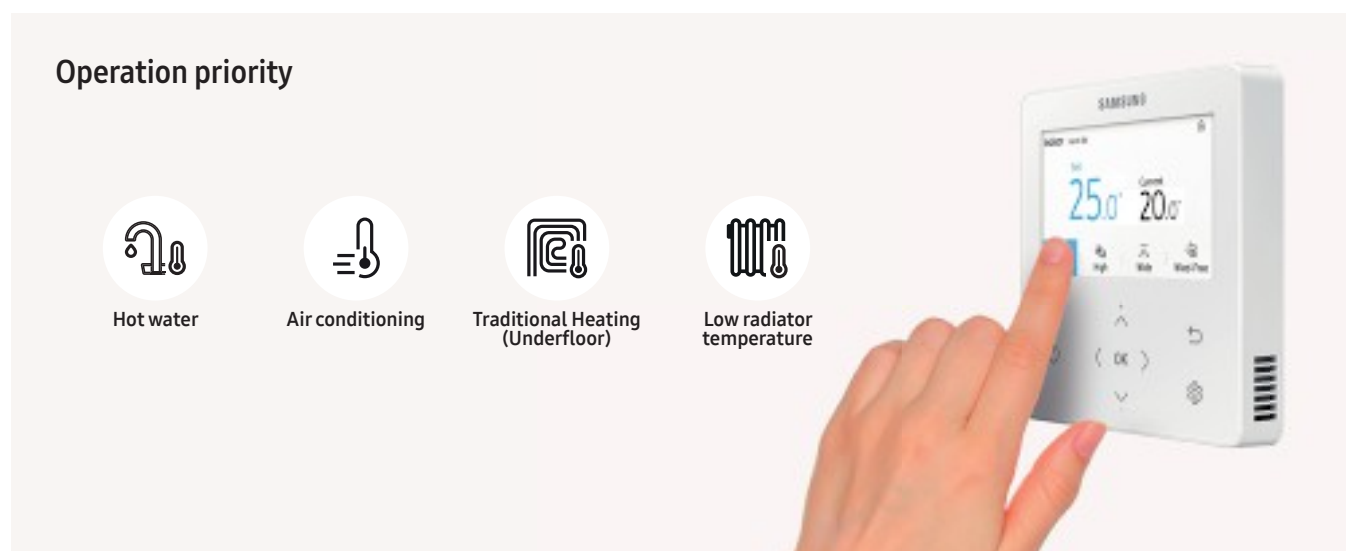

Innovations in detail

TDM Plus

High performance even at low temperatures

The TDM Plus system is equipped with an inverter compressor able to deliver up to 90 % of its nominal potential even at an outside temperature of $-10\text{ }^{\circ}\text{C}$. Operation is guaranteed even if outside temperatures drop up to $-25\text{ }^{\circ}\text{C}$.



Quiet Operation

The Silent function allows you to reduce noise levels of the outdoor unit up to 7 DB (in 3-steps), making it ideal for operation even at night. Activation is programmable through the remote controller.



Emergency Mode

Even in case of interruption of the operation of the outdoor unit, the ClimateHub guarantees the production of hot water.



PV enabled & Smart Grid Ready

It allows to optimize the self-consumption of electricity produced by photovoltaic panels. Connection is already prepared on the hydronic modules and in the ClimateHub and Samsung EHS systems.

QUIET OPERATION

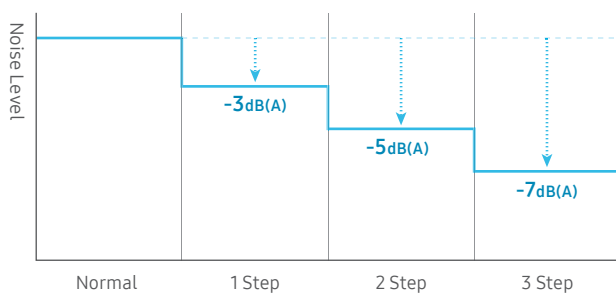

SMART GRID MANAGEMENT

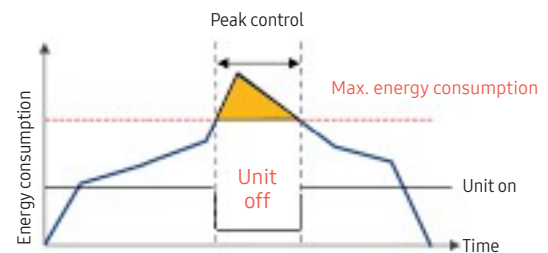

Connection is managed internally by turning it off in peak situations.



Innovations in detail

TDM Plus WindFree™ Deluxe

WindFree™ Cooling

WindFree™ Cooling mode keeps the room comfortably cool. It cools gently and quietly, dispersing air through 23,000 microholes so that consumers never have to deal with the unpleasant feeling of a cold draft on their skin. This results in a "Still Air" environment¹ with a very low air speed and limited noise². The advanced airflow structure of this mode also means that it cools a wider and larger area more evenly. And it consumes up to 77% less energy than Fast Cooling mode³ so consumers can stay comfortably cool while reducing energy costs.

¹ ASHRAE (the American Society of Heating, Refrigerating, and Air-Conditioning Engineers) defines "Still Air" as air currents moving at speeds below 0.15 m/s, with no cold drafts.

² Tested on the AR12TXCAAWKNEU model in an anechoic environment. WindFree™ mode generates 23 dB(A) of noise, compared to 26 dB(A) produced by the conventional Samsung model. Sound pressure level is a relative value, depending on the distance and acoustic environment. Sound pressure level may differ according to operating conditions.

³ Tested on the AR12TVEAAWKNA model under specific testing conditions, based on the power consumption of Fast Cooling mode versus WindFree™ Cooling mode.

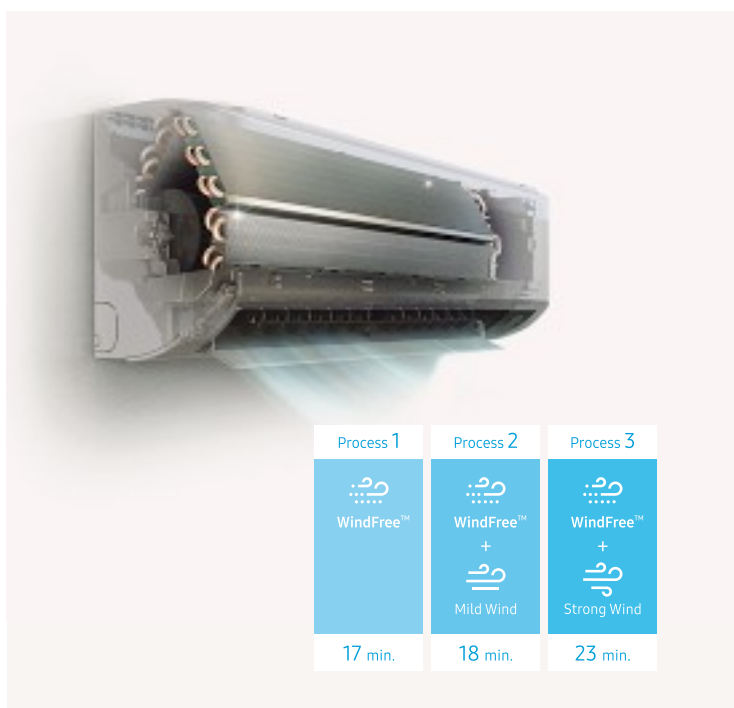
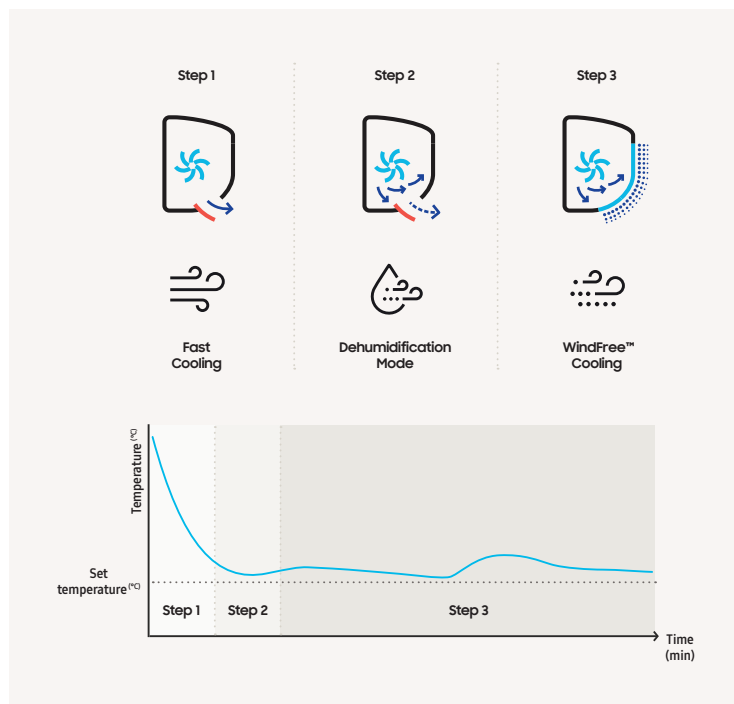

Auto Clean

The Auto Clean functionality enables cleaning of the heat exchanger anytime after you turn off the unit. This function automatically dries the Heat Exchanger using a 3 step process and prevents the build up of bacteria and odors. It can easily be enabled or disabled with the click of the remote controller.

Easy Filter Plus

Unlike conventional filters that may be difficult to access the Easy Filter Plus is located externally on the top of the unit. This means it can be easily removed and cleaned without needing to open a cover or pull hard on it. Thanks to the filter's dense mesh it's very effective at capturing dust and therefore keeping the Heat Exchanger clean and working efficiently. The special coating on the filter helps protect residents from certain airborne contaminants¹.

¹ Tested in an external Korean test lab (FITI). Data has been measured under specific testing conditions and may vary depending on environmental factors and individual use. Certain airborne contaminants referred to are Escherichia coli ATCC 25922, Staphylococcus aureus ATCC 6538.

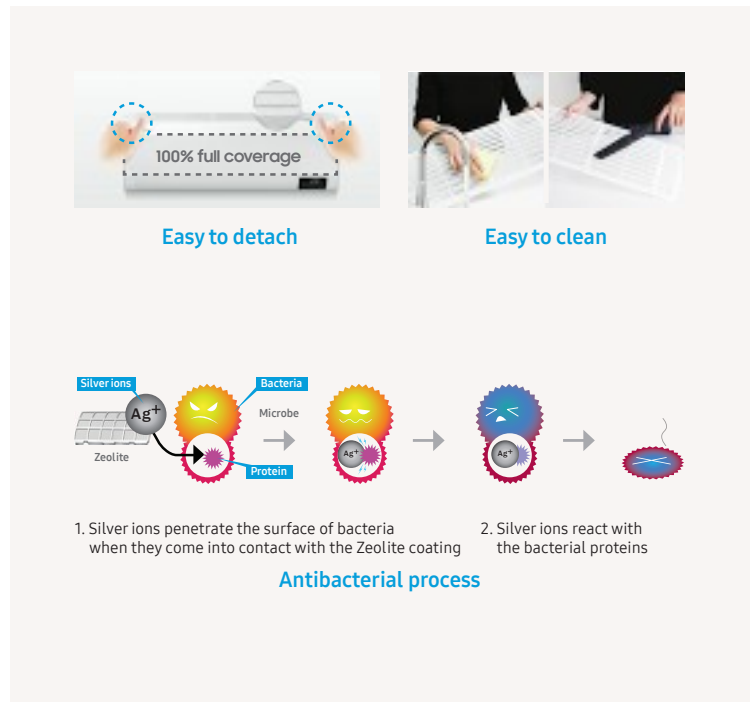

Two screw points

No special tool needed

Samsung's roller type bracket makes mounting the unit much easier. Simply hang it on the unit and find the best place to install it by sliding the bracket from side to side.

Assembled parts (6)/ Screw points (5)	45% ↓	Assembled parts (3)/ Screw points (2)
Installation time¹: 9.3 min		Installation time¹: 5.1 min

¹ Tested on the AM022TINVDKHEU model compared with the Samsung AM022JNVDKHEU model under specific conditions and may vary on specific factors

Easy Installation and Servicing

The TDM Plus WindFree™ wall-mounted air conditioner features a snap-fit bottom cover that can be easily opened and closed. There are two screw points which allows for convenient installation and servicing. Unlike conventional brackets that can be fitted on two fixed hooks, the unit uses a roller type bracket that simplifies the installation process. This makes it easy to mount by installing the bracket on the wall and sliding it effortlessly into the exact position you want.

Innovations in detail

TDM Plus Slim Duct

2-way Air Inlet

The TDM Plus Slim Duct has a 2-way air inlet – bottom or rear – that gives much more flexibility in selecting an installation location. It can be configured to provide the optimum airflow to almost any room, while being concealed behind ceilings.

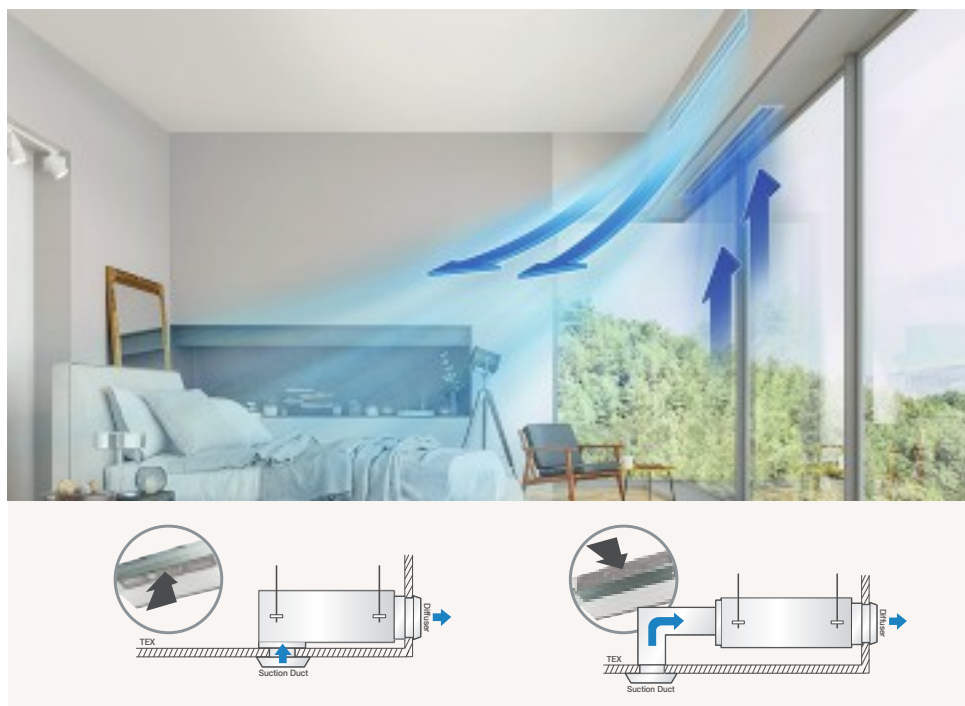

Slim & Compact Design (199 mm Height)

Enhance the look and feel of almost any space with the TDM Plus Slim Duct. Being 199 mm high and 700 mm¹ wide, its slim and compact design is highly elegant, so it can be discretely concealed in many locations. It also makes installation, maintenance and repair quick and easy, so it's ideal for a wide range of businesses and residential homes.

¹ Based on the AM036KNLDEH/EU model.
The width of other models may vary.



TDM Plus Duct

Auto ESP Adjustment

Enjoy maximum comfort and efficiency with minimum effort. The Auto ESP Adjustment automatically optimizes the air volume and pressure and minimizes noise, ensuring consistent cooling and heating in any situation. The external static pressure (ESP) can also be adjusted using a remote control. The Auto ESP adjustment feature is applicable only in MSP Duct lineup.



3-way Service Access

Install the ducted air conditioner in various locations, but still enjoy easy access for servicing. It can be accessed from three directions –top, side and bottom– using an easy to remove Slide Fit cover. So it's simple to maintain wherever it is installed in, which saves time and money.

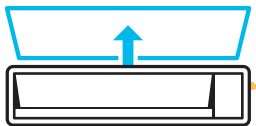

Top access

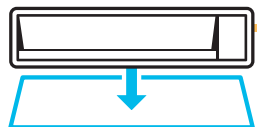

Bottom access

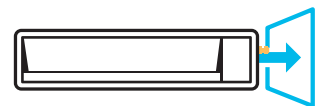

Side access

Innovations in detail

TDM Plus Console

Slim and Smart Design

The TDM Plus Console has a slim and smart design. Being just 199 mm thick, it will fit into almost any space and helps maintain optimal temperature. An innovative panel also prevents dust from accumulating. The black touchscreen display adds convenience and elegance.

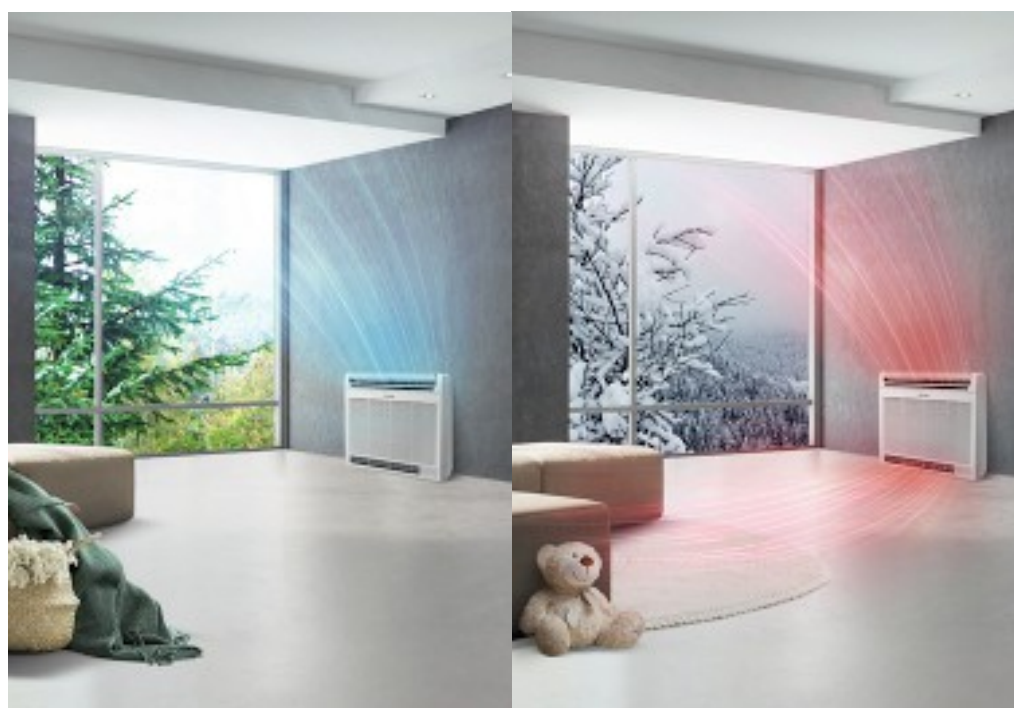

2-Way Air Outlets

The 2-Way Air Outlets ensure that every inch of space quickly reaches the desired temperature, and stays that way. Warm air is expelled from the bottom air outlet, helping to spread warmth evenly throughout the room.



Silent Mode

The TDM Plus Console allows for a selection of 4 operating modes (High, Medium, Low and Silent) to enjoy optimal heating and cooling in a variety of situations. In Silent mode it generates a quiet, but comfortable airflow with a noise level of 23 dB(A)¹.

¹ Based on internal testing. Results may vary depending on individual use.





Innovations in detail

EHS Mono HT Quiet

Hot Water Temperature

The EHS Mono HT Quiet combines advanced features to achieve hot water temperature of 70°C¹ and ensures that it is provided reliably. It combines various advanced features to achieve an incredibly hot water temperature and ensure that it provides a 100% heating performance even in extremely cold weather as low as -25°C.

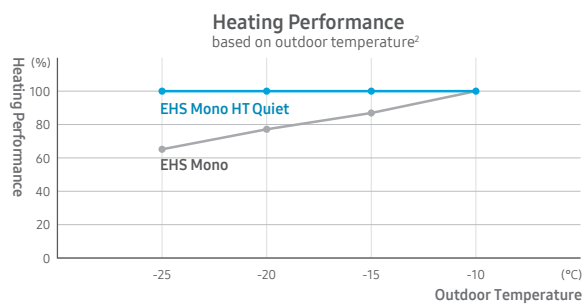
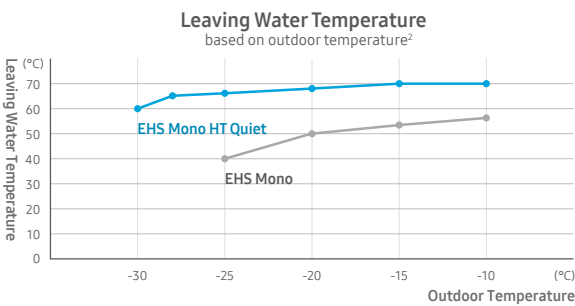

¹ Leaving water temperature, when the outdoor temperature is between -15°C ~ 43°C. Results may vary depending on the actual usage conditions.

² Based on internal testing on an EHS Mono HT Quiet (AE120BXYDGG) outdoor unit, compared to a conventional EHS outdoor unit (AE120RXYDGG). Results may vary depending on the actual usage conditions.

Key features to achieve Hot Water Temperature are Enlarged heat transfer area, Flash injection technology and Strengthened compression parts.

Enlarged Heat Transfer Area

The EHS Mono HT Quiet has an enlarged heat exchanger that is capable of transferring much more heat at once. Its heat transfer area is approximately 11.9% larger¹ to help exchange heat quickly.

¹ Based on Samsung's measurements on an EHS Mono HT Quiet (AE120BXYDGG/EU) model compared to a conventional outdoor unit (AE120RXYDGG/EU) with the same capacity.

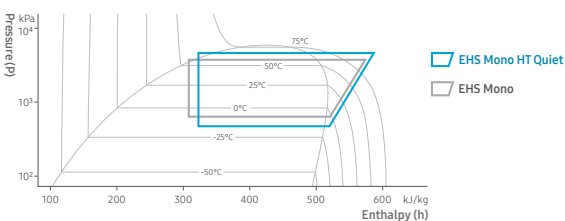
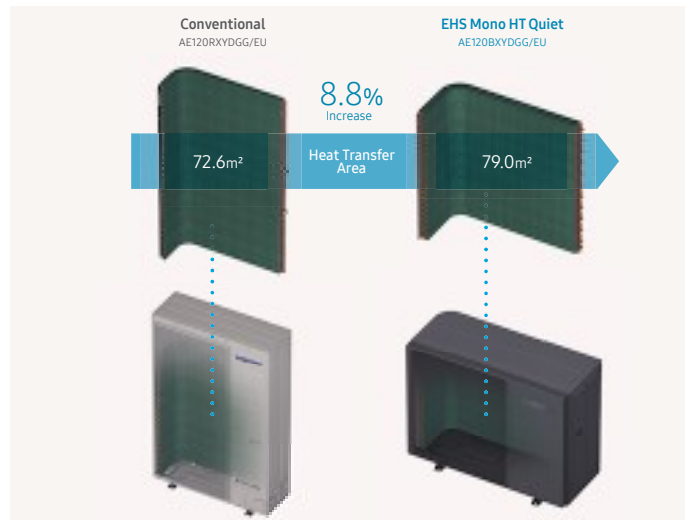

Flash Injection Technology

The EHS Mono HT Quiet outdoor unit has a new Scroll Compressor that can compress refrigerant at much higher pressure, while its Flash Injection Technology increases the flow of refrigerant, so the compressor continues working reliably. Even at -30°C it can supply hot water of up to 60°C for non-stop comfort in the coldest conditions¹.

¹ Based on internal testing. Results may vary depending on the actual usage conditions.

Strengthened Compression Parts

To endure the higher pressure created by a new Scroll Compressor, the EHS Mono HT Quiet uses high impact Reed Valves, which are thicker and stronger, and an extended Oil Groove, which provides sufficient lubricant to ensure the performance and reliability of the compressor. As a result, the compression ratio has increased by approximately 31%¹.

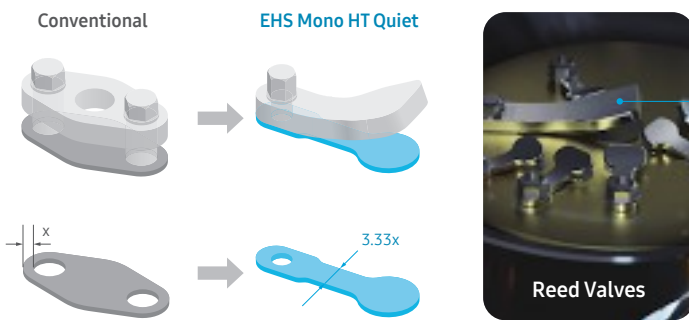

With enhanced durability and response rate, the Reed Valves endure much higher discharge pressure, which has increased by approximately 27%.

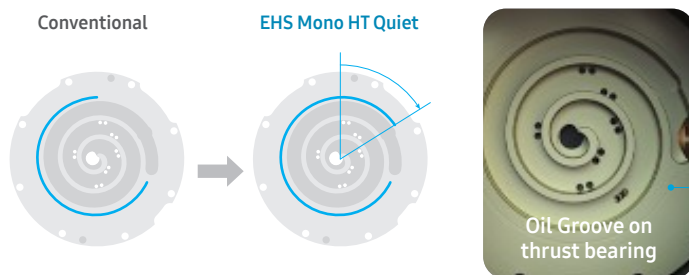

With a 58° extended Oil Groove on the thrust bearing, the lubrication area has increased by about 24%. So, the compression part keeps working stably even under an increased discharge pressure.

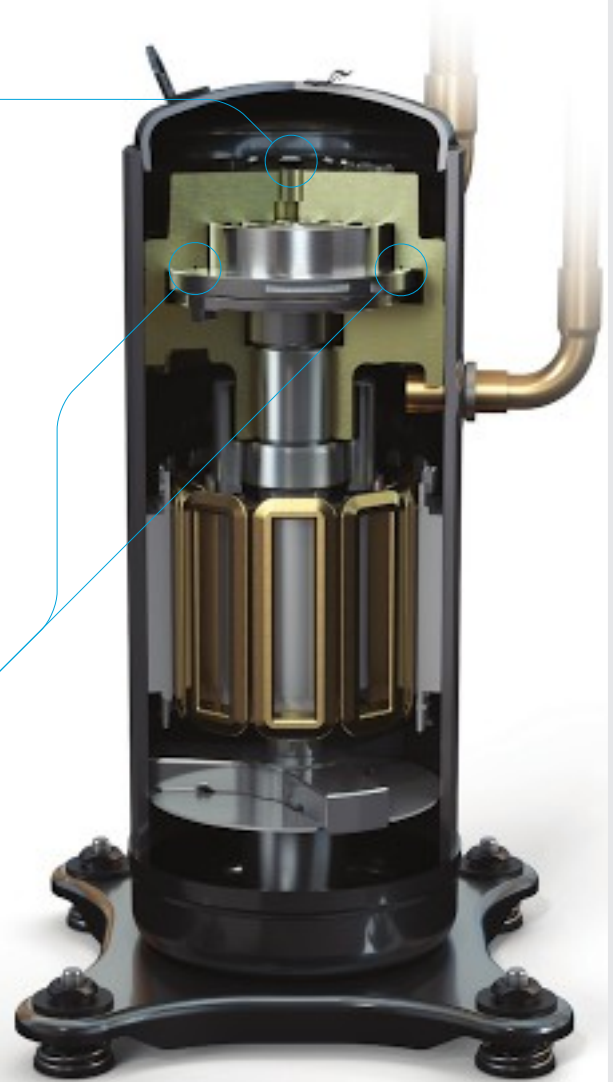

¹ Compression ratio = Discharge pressure/Suction pressure. Based on internal testing on an EHS Mono HT Quiet outdoor unit, compared to a conventional EHS outdoor unit. As a result, the discharge pressure has increased from 43 to 55kgf/cm²G, and the compression ratio has increased from 13 to 17.



Low Noise

With the introduction of new technologies for noise reduction, the EHS Mono HT Quiet operates quietly with noise levels as low as 35 dB(A)¹ using a 4-step Quiet Mode to meet strict sound level requirements, while maintaining a heating performance of up to 8.1kW.

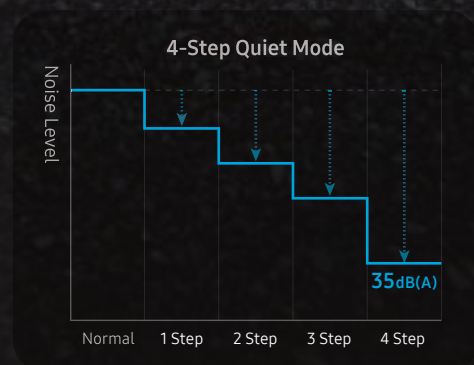

¹ Based on internal testing. The noise level is measured 3m away from the front of the outdoor unit, in an anechoic room with an outside temperature of 7°C. Results may vary depending on environmental factors and individual use. The Quiet Mark is applicable for UK & EU territories only.

Innovations in detail

EHS Mono HT Quiet

Key features to achieve Low Noise are Multi-Serration Fan, 2-layered insulation with groove grid felt, Spring grommet for the compressor mounting and Reinforced crank shaft in the compressor.

Multi-serration Fan

The combination of large serration on the inner part and a small serration on the outer part minimizes the air vortex around the wing tip and significantly reduces the noise generated by the movement of the fan.

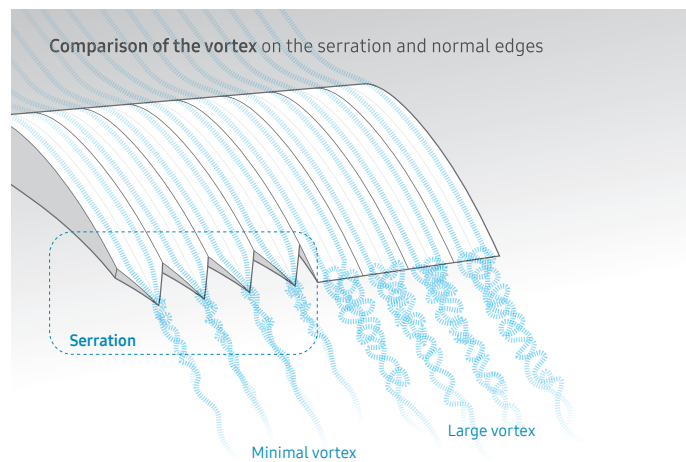
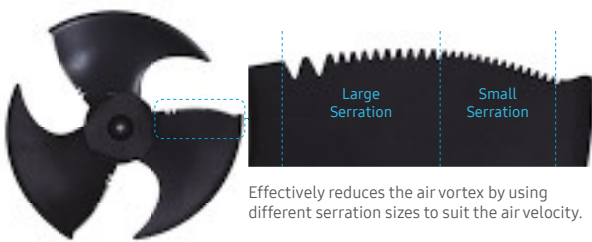

2-layered Insulation with Groove Grid Felt

The 2-layered Insulation consists of Compression Felt on the compressor and an enclosure inside the cabinet, effectively blocks noise. The enclosure is made of a high-performance material¹ with a patented² Groove Grid Felt design, which absorbs the various noises produced by the compression parts and vibration.

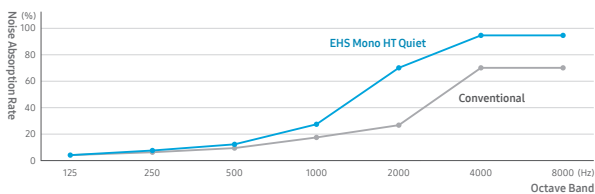

¹ Based on internal testing of the Noiselite-600G, compared to the PET-10T. The results only relate to individual materials and not the whole product, and may vary depending on the actual usage conditions.

² Patent No.:P2022-0012826.

Innovations in detail

EHS Mono HT Quiet

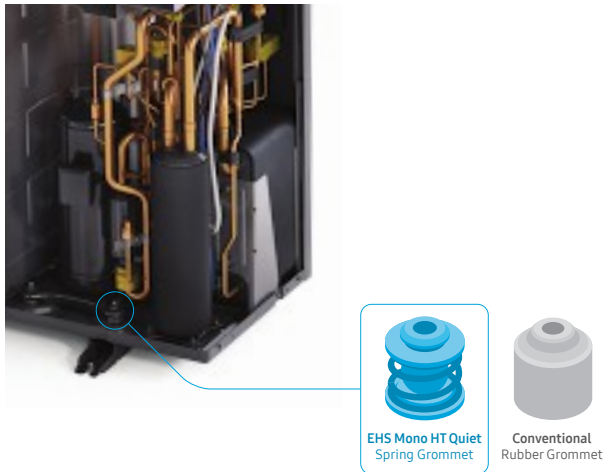

Spring Grommet for the Compressor Mounting

By using spring grommets instead of rubber grommets it absorbs the vibration produced by the compressor and minimizes the resulting noise. It drastically reduces the vibration transfer rate by 90%¹, particularly in the low frequency domain (14~40Hz), which creates significant vibration.

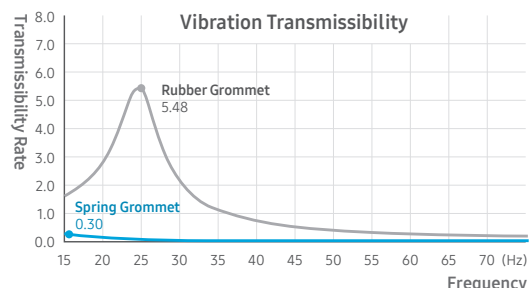

¹ Based on internal testing of the spring grommet, compared to the rubber grommet. Results may vary depending on the actual usage conditions.

Reinforced Crank shaft in the Compressor

The compressor in the EHS Mono HT Quiet introduces a reinforced crankshaft, with a greater diameter and thickness, to shift low frequency noise to a high frequency domain. As a result, it reduces resonant noise of low frequency by approximately 21%¹.

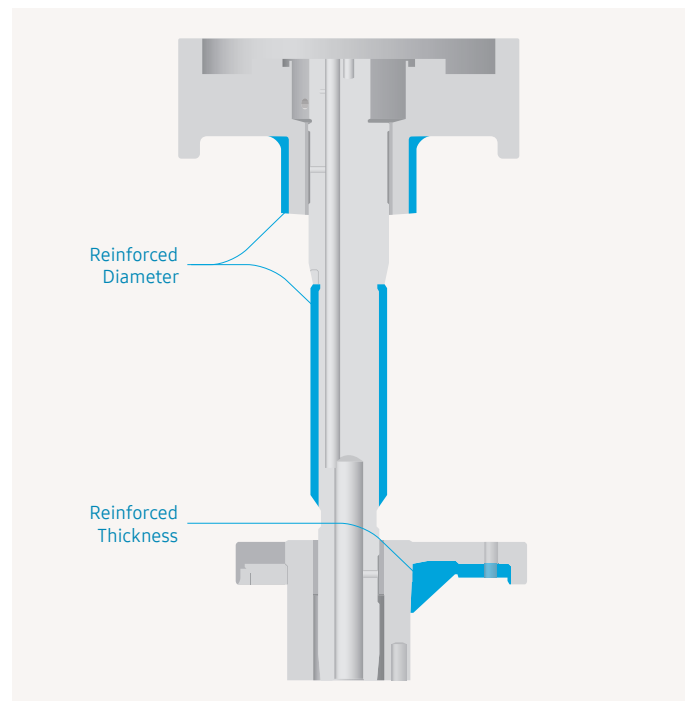
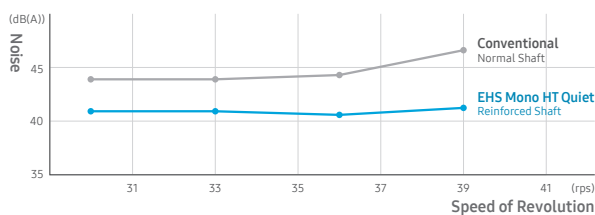

¹ Based on internal testing. In Quiet Mode at 39rps (revolutions per second), noise was reduced from 54.2dB(A) to 42.5dB(A). Results may vary depending on the actual usage conditions.



Innovations in detail

EHS Mono HT Quiet

Weather Proof

The EHS Mono HT Quiet outdoor unit features improved anti-corrosion capabilities on the heat exchanger and chassis to ensure maximum durability in harsh environments.

Key features that makes the product weather proof are Durafin Ultra & GI Steel plate, Antifreeze protection control, Elevated base design with a base heater, Antifreeze protection heater (PHE) and Heat sink.

Durafin™ Ultra & GI Steel Plate

An anti-corrosive layer and a hydrophilic layer disperses water and reinforces its corrosion-resistance, which was proven using the Salt Spray Test (SST) over a period of 3,000 hours¹. The outdoor unit uses Galvanized Iron (GI) Steel Plate with a PE powder coating of up to 100µm thickness, which is proven to improve corrosion resistance by 43%, based on the Complex Cycle Test (CCT)².



¹ Based on internal testing, verified by TUV Rheinland, in accordance with ISO 9227, ISO 14993 and ISO 21207 using specimens from the heat exchanger of an EHS outdoor unit. For more details, please contact your local Samsung representative.

² Based on internal testing using corrosion chambers, Q-FOG and CCT-1100. The Complex Cycle Test (CCT) includes cycles of spray (for 2 hours at 35°C), dry (for 4 hours at 60°C with 30% Relative Humidity) and damp (for 2 hours at 50°C with 95% Relative Humidity) conditions. As a result, the Galvanized Iron Steel Plate (GI) formed red rust after 240 hours, which is 43% slower than general Electro-Galvanized Steel Plate (EGI) which forms red rust after 168 hours.



Antifreeze Protection Control

In the EHS Mono HT Quiet, the hydraulic parts that provide hot water are built into the outdoor unit. As a result, the water pipe exposed to the outside conditions might freeze if it stops operating in cold weather of below 0°C¹. So, its Antifreeze Protection Control continuously monitors the operating status and the outdoor temperature, and prevents the water pipe from freezing by forcibly pumping the water after a certain period of time².

¹ For external water pipes, the system must use antifreeze: Propylene Glycol with a toxicity rating of Class 1 as listed in Clinical Toxicology of Commercial Products, 5th Edition. Please refer to the installation manual or detailed antifreeze specifications.

² For example, if it has stopped operating for 60 minutes when the outdoor temperature is 3°C, the pump on the water pipe side is forcibly operated to prevent the water from freezing in the water pipe.

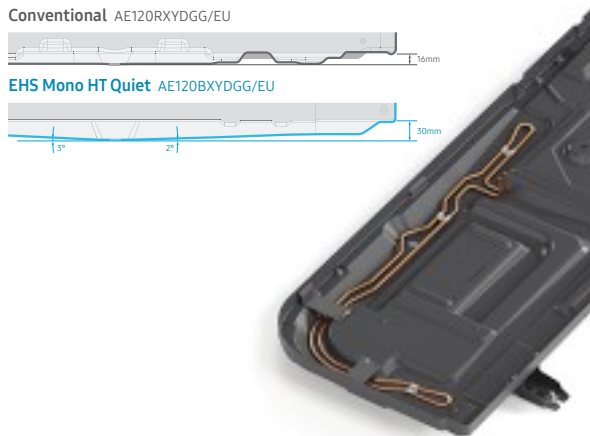

Elevated Base Design with a Base Heater

During the heating operation in cold weather (-25°C or below), the defrost cycle used to remove ice on a heat exchanger can cause water to condense on it. The EHS Mono HT Quiet has an elevated base design with deepened and slanted gutters, so it drains condensed water much faster¹ to prevent it from freezing inside the cabinet. So, a base heater is equipped as a standard, which can quickly melt ice on the base and ensure the reliability of its heating operation.

¹ Based on internal testing on the EHS Mono HT Quiet outdoor unit compared to a conventional EHS outdoor unit.

Operates across a Wider Temperature Range

The EHS Mono HT Quiet supplies hot water regardless of the external conditions. Flash Injection Technology ensures that it can maintain its heating performance in cold weather, while a Heat Sink radiates the heat of the inverter circuit more effectively to extend the operating temperature range.

Antifreeze protection heater (PHE)

When an outdoor unit turns off or is malfunctioning in cold weather, water inside it may freeze and burst vital parts. The EHS Mono HT Quiet has a heater on the Plate Heat Exchanger (PHE) that senses the temperature of the water in the PHE and keeps it above zero. So, it prevents the PHE from becoming frozen and bursting when it is not operating, even if the outdoor temperature reaches -30°C ¹.

¹ Based on internal testing using an EHS Mono HT Quiet AE140BYXDGG model. Operated in an outdoor temperature of -30°C for 20 hours.

² Only illustrative. The heater is not seen from the outside of insulation.

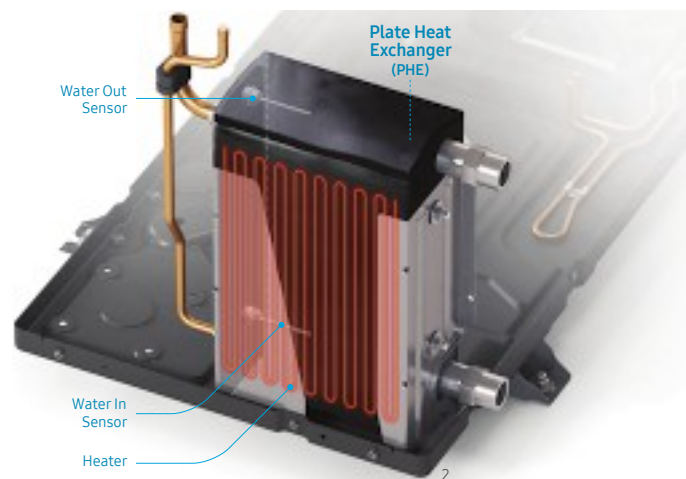

Heat Sink

The inverter circuit generates a lot of heat, which affects the entire system's performance. The Insert Diecasting Heat Sink effectively radiates heat from the inverter circuit. It helps extend the heating operation temperature from 35°C to 43°C ¹, so it reliably supplies hot water even in severely hot weather.

¹ Based on internal testing on the EHS Mono HT Quiet outdoor unit compared to a conventional EHS outdoor unit.





Slanted Grille

A new grille design has a 6° slope and is 18mm deep, so it screens the inside from sight when you pass by it, even if you are just 1m away*.

* Based on a viewing height of 1,700mm.

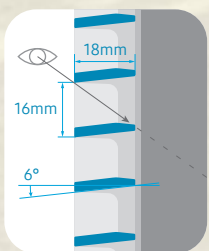



Low Height

The EHS Mono HT Quiet outdoor unit is approximately 1m in height. So, it can be installed under a balcony window, which enhances your home interior as it does not affect the view out of the window.



Innovations in detail

Wall-mounted Hydro Unit

Flexibly fits into a limited space, easily expands to optimize your comfort

The Wall-mounted Hydro Unit contains a Plate Heat Exchanger where the heat collected outside is exchanged to the water system to heat your living space or domestic hot water on the inside. The compact design provides a lot of flexibility for installing. It includes a flow sensor and a backup heater to ensure that the required water temperature is always maintained. Single phase 230 V or three-phase 400 V models can be selected to suit the requirements of the house.

Product Structure

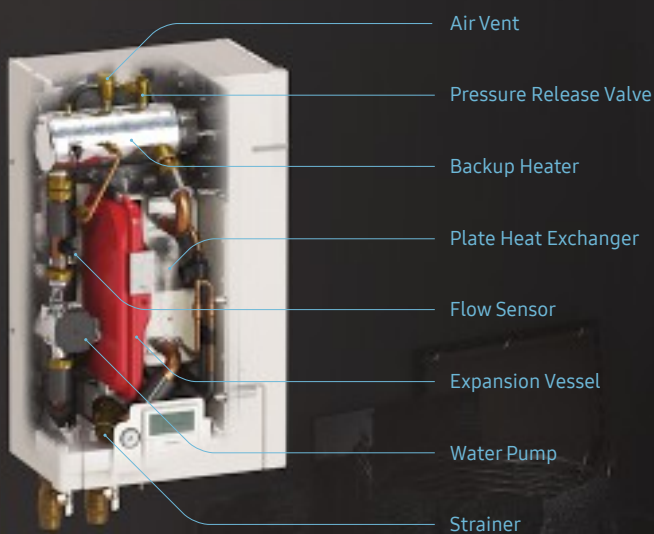

Requires less space, frees up more floor space

Compact Design

The Wall-mounted Hydro has a compact design that doesn't take up any extra space on the floor, you have much greater flexibility in choosing the right location to install it. In addition, it has similar shape and dimensions as conventional boiler systems, so it makes it simpler to replace or install it instead of a boiler.



Easy to optimize for your needs

A Variety of Pipe Fittings

The Wall-mounted Hydro provides the functionality needed for interlocking control with various accessories that may be used in the design. You may simply choose from a variety of solutions and optimize the design to suit the specific conditions of the house and the needs of the users.

Innovations in detail

DVM Hydro Unit

Performance

The Samsung DVM Hydro unit provides a single solution for cooling, heating and hot water that is both efficient and easy to manage.

An Integrated Solution in One System

The DVM Hydro system is compatible with all DVM S outdoor units and can be added to create a single, integrated solution for cooling, heating and hot water that's simple to manage. So it ensures much greater efficiency to suit a variety of demands, generating substantial energy and cost savings all year round with its high-efficiency heat pump technology.

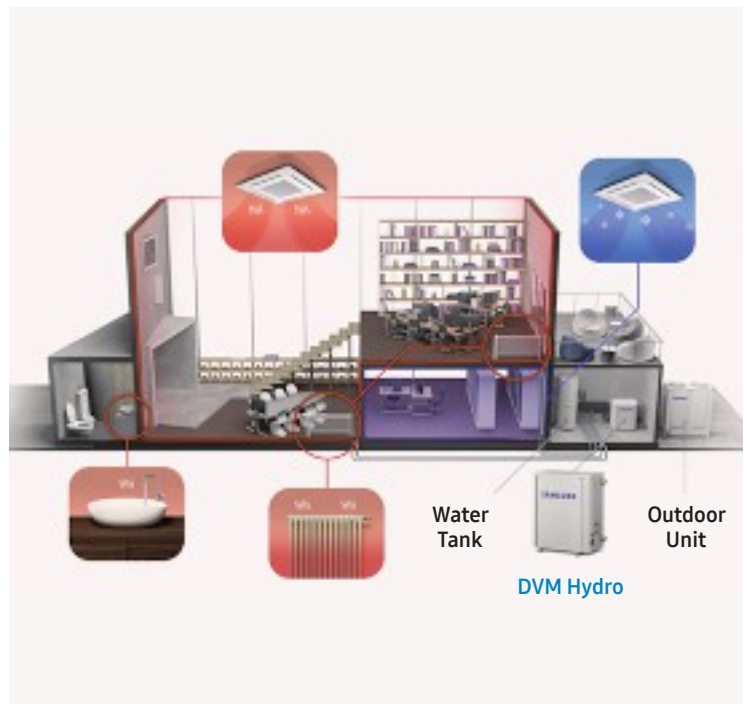

2 Types - with a Choice of Hot Water needs

The DVM Hydro is available in two types. The DVM Hydro HE provides water at a mid temperature of 50 °C, while the DVM Hydro HT's advanced, double compression technology generates much hotter water at 80 °C. The perfect solution to satisfy the requirements of various sites.

Installation & Control

The Samsung DVM Hydro is easy to install and connect to a range of other devices, and can also be independently or centrally controlled.

Simple & Easy Connection for External Control

The DVM Hydro is very quick and easy to install and use for many different purposes. It includes a range of connections for various external input and output devices, such as Tank Sensors, Booster Heaters, 2- and 3-way Valves, and Room Thermostats.

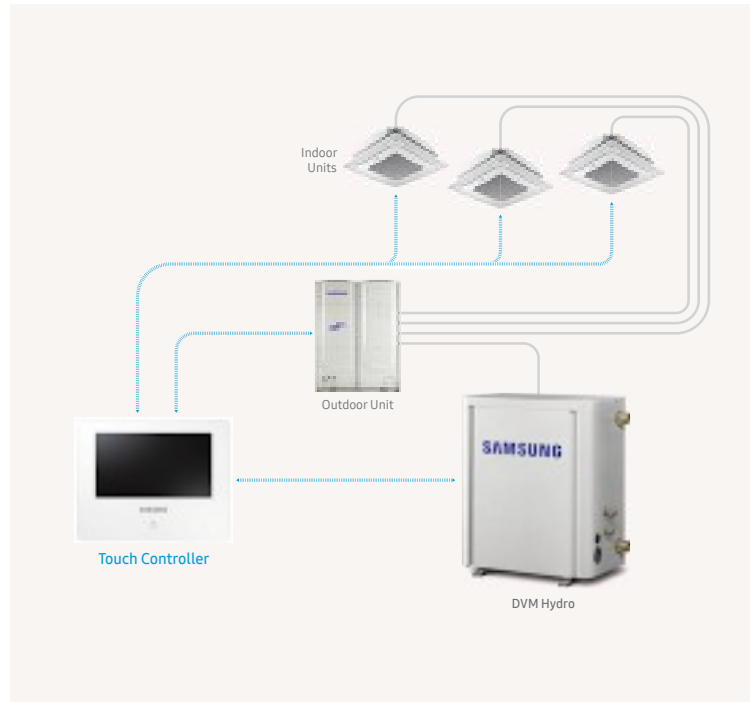

Integrated Control System

The DVM Hydro can be independently or centrally operated along with a variety of Samsung DVM systems. For standalone use on individual sites it has its own control system or, using the Samsung DVM S Controller, it can be integrated with various DVM systems eg. for water and air, and managed centrally.

Innovations in detail

SmartThings



New Generation Wireless Smart Home Automation

SmartThings is one of the largest open ecosystems of connected devices worldwide and is available on both Android and iOS. It is compatible with the leading voice assistants and a wide range of different brand devices, giving control over smart devices in one place.

With the SmartThings App much more can be done than just turning devices on and off. The App makes it possible for devices from Samsung and other brands to work together easily at fixed times by creating "Automations" or "Scenes". Additionally, the Geo-Fencing functionality allows the room temperature to be automatically set at the desired level when the user approaches within a preset distance.

A wide range of smart devices can be managed

With the help of the SmartThings Hub a wide range of devices can be integrated into the ecosystem, manageable with a single app, through Zigbee and Z-Wave protocols, and make them interact with evolved logic. The user can receive security notifications, detect water leaks, or schedule lights to come on with SmartThings sensors and plugs. In this way, it is possible to create scenarios and automations by transforming the house into a smart home with simple gestures and without structural interventions.

SmartThings Multipurpose sensor

Easily installable on doors and windows, it recognizes their opening thanks to a magnetic sensor. By using the multi purpose sensor you can reduce heat loss as the air conditioner or EHS will be turned off when the window is open.

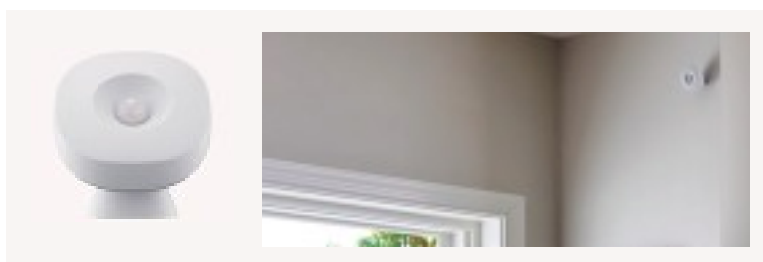

SmartThings Motion sensor

Allows to set automatic lighting and other devices when it detects movement. When away from home, the Motion sensor can send an alarm signal to the Smart Phone if it detects unwanted movements.

SmartThings Hub

This is the brain of the Samsung home automation: It communicates with all devices that can be managed via the app and allows for management via SmartThings. Compatible with voice assistants like Bixby¹, Google Home¹ and Amazon Alexa¹.

¹ Voice control is supported by AI speakers such as Samsung Bixby 2.0, Google Assistant (Google Home) and Amazon Alexa. Google Assistant is not available in certain languages and countries. Google is a trademark of Google LLC.

Compatible with:



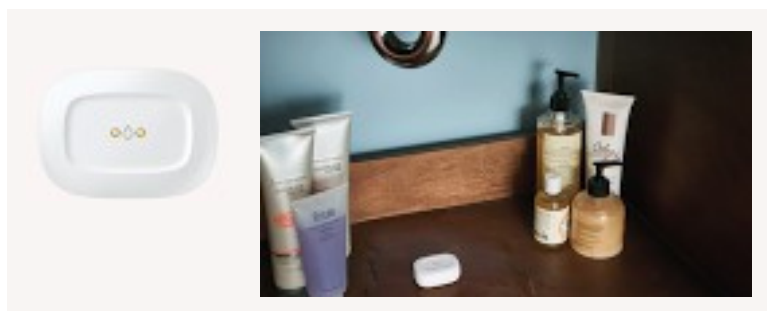

SmartThings Water Leak sensor

Place this sensor near the ClimateHub water tank, shower and or pipes to detect any water leaks or condensation. This can help to quickly identify leakage when they occur.

SmartThings button

The button can be positioned at any point of the house, allowing to activate any smart device connected to it, depending on the set mode.

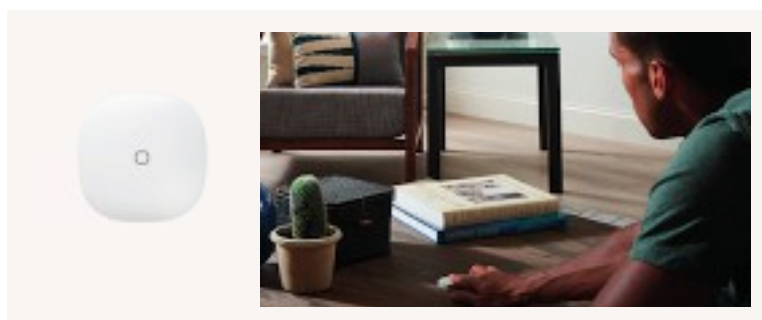

Contact your local Samsung Representative for more information on SmartThings.

Innovations in detail

Anytime, anywhere: it's all in your hands

SmartThings + Wi-Fi Kit 2.0

Let SmartThings¹ take care of your home so you can focus on what matters most in life. SmartThings¹ Home Care Wizard keeps tabs on your household devices, sends you notifications to replace parts, and offers trouble-shooting solutions if something goes wrong. Or simply tell Bixby what you want².



Bixby

works with the
Google Assistant

works with
amazon alexa

Adjust settings

Lets you monitor the indoor temperature and settings and adjust them.



Energy monitoring

Lets you view your daily, weekly, and monthly energy usage at a glance and notifies when you have exceeded your energy usage.



Energy service

Lets you quickly check the energy usage of multiple devices in your home.



Automation

Automatically operates to suit your preferred home environment.



Welcome heating

Performs pre-heating and/or pre-cooling before you arrive back home.



¹ Available on Android and iOS devices. A Wi-Fi connection, Samsung account and an optional Wi-Fi Kit (MIM-H04N) are required. The GUI images on this page may vary by the version of the SmartThings App.

² Bixby is Samsung's brand of artificial intelligence (AI)/Internet of Things (IoT) voice assistant. A Wi-Fi connection and a Samsung account are required. Bixby only recognises certain accents and dialects of English (UK), English (US), French (France), German (Germany), Italian (Italy), Korean (South Korea), Mandarin Chinese (China), Spanish (Spain) and Portuguese (Brazil). Other languages to be supported.

Just walk into your home, and comfort welcomes you

Home Automation with Geofencing functionality

The Samsung EHS will operate in your preferred mode according to the settings you choose. The geofencing functionality will be automatically activated within a pre-set distance of the building so pre-heating/cooling will start.

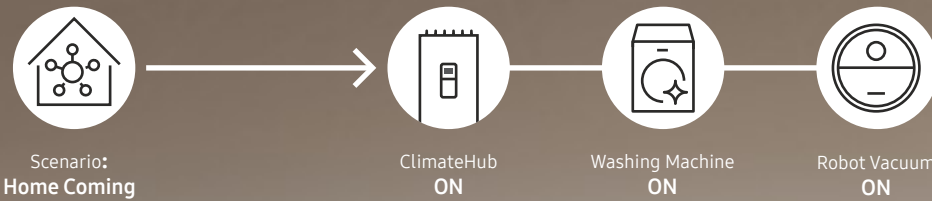

EHS





Line-up

ClimateHub



Outdoor Unit

Tank Integrated Hydro Unit

Type	Power	Model Name	Capacity	Tank Integrated Hydro Unit (Split)			Tank Integrated Hydro Unit (Mono)			Tank Integrated Hydro Unit (TDM Plus)	
				200 L(1Φ) AE200RNWSEG/ EU	260 L(1Φ) AE260RNWSEG/ EU	260 L(3Φ) AE260RNWGG/ EU	200 L(1Φ) AE200RNWMEG/ EU	260 L(1Φ) AE260RNWMEG/ EU	260 L(3Φ) AE260RNWGG/ EU	200 L(1Φ) AE200TNWTEH/ EU	260 L(1Φ) AE260TNWTEH/EU
R32 Outdoor Unit	Mono	1Φ	AE050RXYDEG/EU	5.0 kW				•			
			AE080RXYDEG/EU	8.0 kW				•	•		
			AE120RXYDEG/EU	12.0 kW				•	•		
			AE160RXYDEG/EU	16.0 kW				•	•		
	3Φ	AE080RXYDGG/EU	8.0 kW						•		
		AE120RXYDGG/EU	12.0 kW						•		
		AE160RXYDGG/EU	16.0 kW						•		
	Split	1Φ	AE040RXEDEG/EU	4.0 kW	•	•					
			AE060RXEDEG/EU	6.0 kW	•	•					
AE090RXEDEG/EU			9.0 kW	•	•						
3Φ		AE090RXEDGG/EU	9.0 kW			•					
R410A Outdoor Unit	TDM Plus	1Φ	AE044MXTPEH/EU	4.4 kW						•	•
			AE066MXTPEH/EU	6.6 kW						•	•
			AE090MXTPEH/EU	9.0 kW						•	•
		AE120MXTPEH/EU	12.0 kW						•	•	
		AE160MXTPEH/EU	16.0 kW						•	•	
		3Φ	AE090MXTPGH/EU	9.0 kW						•	•
	AE120MXTPGH/EU		12.0 kW						•	•	
	AE160MXTPGH/EU		16.0 kW						•	•	
	R32 Outdoor Unit	Mono HT Quiet	1Φ	AE080BXYDEG/EU	8.0 kW			•	•		
AE120BXYDEG/EU				12.0 kW			•	•			
AE160BXYDEG/EU				16.0 kW			•	•			
3Φ		AE080BXYDGG/EU	8.0 kW						•		
		AE120BXYDGG/EU	12.0 kW						•		
		AE160BXYDGG/EU	16.0 kW						•		

TDM Plus Indoor



Type		WindFree™ Deluxe	Slim Duct	MSP Duct	Console
Capacity	2.2 kW	•	•		•
	2.8 kW	•	•		•
	3.6 kW	•	•	•	•
	5.6 kW	•	•	•	•
	7.1 kW	•		•	
	9.0 kW			•	

Optional Controller



Model	MIM-H04EN
Model name	Wi-Fi Kit 2.0
Maximum connectible Indoor Units	16
App	SmartThings
Voice recognition	Bixby
Welcome Cooling/Heating	Geofencing
Automation	Customised control with a variety of execution rules
Add scene	Easy control throughout customised user mode
Energy monitoring	Individual energy monitoring up to 16 outdoor units
Product dimensions (mm) W x H x D	185 x 130 x 29

Model	MWR-WW10*N
Model name	Touch Controller
Screen size/type	4.3" Color LCD display
Intuitive user interface	Dynamic navigation with simplified buttons
Operation	Heating / Cooling/ Auto / DHW
Functions	Smart Grid Ready / PV Ready / 2-zone Control / Energy consumption monitor / Energy saving
Smart connectivity	SmartThings via optional Wi-Fi Kit 2.0
Languages	
MWR-WW10N	English, German, French, Italian, Spanish, Polish (EN, DE, FR, IT, ES, PL)
MWR-WW10JN	English, Portuguese, Dutch, Greek, Czech, Slovak (EN, PT, NL, EL, CS, SK)
MWR-WW10KN	English, Finnish, Swedish, Norwegian, Danish, Lithuanian (EN, FI, SV, NO, DA, LT)
Product dimensions (mm) W x H x D	120x120x19

Line-up

EHS with Third Party DHW Tank

Mono with Third Party DHW Tank



Outdoor Unit



Mono Control Kit



DHW Tank
(third party)

Type	Power	Model Name	Capacity	Mono MIM-E03CN		
R32 Outdoor Unit	Mono	1Φ	AE050RXYDEG/EU	5.0 kW		•
			AE080RXYDEG/EU	8.0 kW		•
			AE120RXYDEG/EU	12.0 kW		•
			AE160RXYDEG/EU	16.0 kW		•
	3Φ	AE080RXYDGG/EU	8.0 kW		•	•
			AE120RXYDGG/EU	12.0 kW		•
			AE160RXYDGG/EU	16.0 kW		•

Split with Third Party DHW Tank



Outdoor Unit



Wall-Mounted
Hydro Unit



DHW Tank
(third party)

Type	Power	Model Name	Capacity	Wall-Mounted Hydro Unit	
				Split(1Φ) AE090RNYDEG/EU	Split(3Φ) AE090RNYDGG/EU
R32 Outdoor Unit	1Φ	AE040RXEDEG/EU	4.0 kW	•	
		AE060RXEDEG/EU	6.0 kW	•	
		AE090RXEDEG/EU	9.0 kW	•	
	3Φ	AE090RXEDGG/EU	9.0 kW		•
R410A Outdoor Unit	1Φ	AE120AXEDEH/EU	12.0 kW	•	
		AE160AXEDEH/EU	16.0 kW	•	
	3Φ	AE120AXEDGH/EU	12.0 kW		•
		AE160AXEDGH/EU	16.0 kW		•

TDM Plus with Third Party DHW Tank

TDM Plus with Third Party DHW Tank



Outdoor Unit



Wall-Mounted
Hydro Unit



DHW Tank
(third party)

Type	Power	Model Name	Capacity	Wall-Mounted Hydro Unit			
				Split(1Φ)		Split(3Φ)	
				AE090BNYDEH/EU	AE160BNYDEH/EU	AE090BNYDGH/EU	AE160BNYDGH/EU
R410A TDM Plus Outdoor Unit	1Φ	AE044MXTPEH/EU	4.4 kW	•			
		AE066MXTPEH/EU	6.6 kW	•			
		AE090MXTPEH/EU	9.0 kW	•			
		AE120MXTPEH/EU	12.0 kW		•		
		AE160MXTPEH/EU	16.0 kW		•		
	3Φ	AE090MXTPGH/EU	9.0 kW				•
		AE160MXTPGH/EU	16.0 kW				•

Line-up

Renovation Solutions

EHS Mono HT Quiet



Outdoor Unit



Mono Control Kit



DHW Tank
(third party)

Type	Power	Model Name	Capacity	Mono MIM-E03CN/MIM-E03EN*
R32 Outdoor Unit	1Φ	AE080BXYDEG/EU	8.0 kW	•
		AE120BXYDEG/EU	12.0 kW	•
		AE160BXYDEG/EU	16.0 kW	•
	3Φ	AE080BXYDGG/EU	8.0 kW	•
		AE120BXYDGG/EU	12.0 kW	•
		AE160BXYDGG/EU	16.0 kW	•

*MIM-E03EN has additional features: Smart Grid ready/PV Enabled/2-Zone control

Alternative Heating Solutions

DVM S Eco with Hydro HT



Outdoor Unit



Hydro Unit HT



DHW Tank
(third party)

Type	Power	Model Name	Capacity	Split(1Φ) AM160TNBFEB/EU	Hydro Unit HT (High Temperature) Split(3Φ) AM250TNBFGB/EU
R410A DVM Outdoor Unit	1Φ	AM050*XMDEH/EU	5 HP/ 14 kW	•	
	3Φ	AM080*XMDBGH/EU	8 HP/ 25 kW		•



Selecting the right heating system

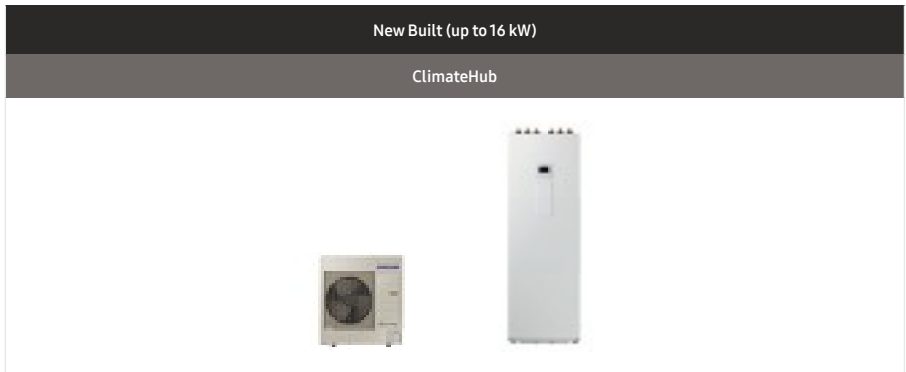

		Mono / Split R32	TDM Plus R410A
Main Function	A2W Cooling	•	•
	A2W Heating	•	•
	A2W Domestic Hot Water	•	•
	A2A Cooling		•
	Maximum Allowable Indoor unit Connections		up to 7 Indoor unit
Comfort	Colour Display	•	•
	Low Noise ¹	•	•
	Outing	•	•
	Schedule / Holiday Mode	•	•
	Emergency Operation	•	•
Feature	Wi-Fi Kit SmartThings	•	•
	Wired Remote Controller	• ²	• ²
	Zone Controller	•	•
	Mixing Valve ⁴	•	•
	3-Way Valve	•	•
	2-Way Valve ⁴	•	•
	Thermostat Control	•	•
	PV Integrated	•	•
	Smart Grid Ready	•	•
	Energy Consumption Monitoring	•	•
Set FSV with SD Card	•	•	
Smart Install	Smart Checking	•	•

Nomenclature

Indoor units

AE 260 A N W S E G

1 2 3 4 5 6 7 8

1	Classification	AE	EHS
		AM	DVM
2	Capacity	x1/10 kW (3 digits)	
		x Litre (3 digits)	
3	Year	J	2015
		M	2017
		R	2019
		T	2020
		A	2021
		B	2022
4	Product Type	N	Indoor Unit (NASA)
5	Product Notation	A/X	RAC Wall-Mounted
		B	Hydro Unit
		J	Console
		L	LSP Duct
		M	MSP Duct
		W	Tank Integrated Hydro Unit
6	Feature	Y	Wall-Mounted Hydro Unit
		D	Standard
		P	
		F	Flagship
		M	Mono
		S	Split
7	Rating Voltage	T	TDM Plus
		E	1 Φ , 220–240 V, 50 Hz
8	Mode	G	3 Φ , 380–415 V, 50 Hz
		B	R134 Heat Pump
		G	R32 Heat Pump
		H	R410A Heat Pump

Outdoor units

AE	090	A	X	E	D	E	G
1	2	3	4	5	6	7	8

1	Classification	AE	EHS
		AM	DVM
2	Capacity	x1/10 kW (3 digits)	
3	Year	F	2013
		J	2015
		K	2016
		M	2017
		N	2018
		R	2019
		A	2021
		B	2022
4	Product Type	X	Outdoor Unit (NASA)
5	Product Notation	E	Split
		M	DVM S Eco
		T	TDM Plus
		Y	Mono
6	Feature	D	Standard
		P	
7	Rating Voltage	E	1Φ, 220~240 V, 50 Hz
		G	3Φ, 380~415 V, 50 Hz
8	Mode	G	R32 Heat Pump
		H	R410A Heat Pump
		R	Heat Recovery

Mono





Specifications

ClimateHub Mono R32

- Integrated solution for heating and domestic hot water.
- Compact unit size with large water tank (200 L & 260 L).
- Intuitive, colour screen touch controller in multiple languages.
- Energy monitoring through touch controller.
- Smooth servicing through the front-mounted service window.
- PV and Smart Grid ready.
- 2-zone Control, suitable for floor heating and radiators.
- SCOP rating of A+++.
- SmartThings compatible with optional Wi-Fi kit.
- Backup heater is included to ensure a minimum water temperature.



		Indoor Unit		AE200RNWMEG/EU	AE200RNWMEG/EU	AE200RNWMEG/EU		
		Outdoor Unit		AE050RXYDEG/EU	AE080RXYDEG/EU	AE120RXYDEG/EU		
		Controller		MWR-WW10N	MWR-WW10N	MWR-WW10N		
System	Operation	Nominal Capacity	Heating A7/W35 ¹ / A7/W55 ²	kW	5.0/4.3	8.0/7.1	12.0/11.3	
			Cooling A35/W18 ¹	kW	5.0	7.5	12.0	
		Power Input (Nominal)	Heating A7/W35 ¹ / A7/W55 ²	kW	1.03/1.52	1.77/2.53	2.65/3.73	
			Cooling A35/W18 ¹	kW	1.14	1.90	2.77	
			COP (Nominal Heating) A7/W35 ¹ / A7/W55 ²	W/W	4.85/2.83	4.52/2.81	4.53/3.03	
			EER (Nominal Cooling) A35/W18 ¹	W/W	4.39	3.95	4.33	
			SCOP LWT 35°C/ 55°C	W/W	4.46/3.2	4.44/3.23	4.69/3.51	
			Seasonal Space Heating enr. efficiency η _s LWT 35°C/ 55°C	ETA%	175/125	175/126	185/138	
			Seasonal Space Heating Eff. class * LWT 35°C/ 55°C	-	A+++ / A++	A+++ / A++	A+++ / A++	
		Current	MCA	A	16.00	22.00	28.00	
			MFA	A	20.00	27.50	35.00	
			Water Flow Rate	Low / Medium temperature	L/min	14.4/7.8	23.1/12.8	34.6/20.4
		Leaving Water Temperature ³	Heating	°C	15-65	15-65	15-65	
			Cooling	°C	5-25	5-25	5-25	
		Functions	Smart Grid Ready / PV Enabled	-	•	•	•	
3-Step Quiet Mode	-		•	•	•			
2-zone Control	-		•	•	•			
Tank Integrated Hydro Unit	Power Supply		Φ, #, V, Hz	1Φ, 2, 220-240 V, 50 Hz	1Φ, 2, 220-240 V, 50 Hz	1Φ, 2, 220-240 V, 50 Hz		
	Water Tank Volume		litres	200	200	200		
	Declared Load Profile		L/XL	L	L	L		
	Average water heating efficiency η _{wh}		ETA%	115	115	110		
	Average Energy Efficiency Class		-	A	A	A		
	Sound	Sound Pressure ⁴	Heating Std	dB(A)	26	26	30	
			Cooling Std	dB(A)	26	26	30	
	Sound Power	Heating Std		dB(A)	40	40	44	
	Heater	Back-up heater Capacity	Default (Option)	kW	2 (4/6)	2 (4/6)	2 (4/6)	
Piping	Water Pipe (Space Heating)	Inlet/ Outlet	Φ, mm	28/28	28/28	28/28		
	Water pipe (DHW)	Inlet/ Outlet	Φ, mm	22/22	22/22	22/22		
Dimensions	Net Weight		kg	130.0	130.0	130.0		
	Net Dimensions (WxHxD)		mm	595 x 1,800 x 700	595 x 1,800 x 700	595 x 1,800 x 700		
Outdoor Unit	Power Supply		Φ, V, Hz	1Φ, 220-240 V, 50 Hz	1Φ, 220-240 V, 50 Hz	1Φ, 220-240 V, 50 Hz		
	Compressor	Type	-	BLDC Twin Rotary	BLDC Twin Rotary	BLDC Twin Rotary		
	Base Heater	Capacity		kW	-	0.15	0.15	
	Sound	Sound Pressure ⁴	Heating Std	dB(A)	45	48	50	
			Cooling Std	dB(A)	45	48	50	
			Sound Power	Heating Std	dB(A)	61	63	64
	Dimensions	Net Weight		kg	58.5	76.0	110.0	
		Net Dimensions (WxHxD)		mm	880 x 798 x 310	940 x 998 x 330	940 x 1,420 x 330	
	Refrigerant	Type			R32 (Fluorinated greenhouse gas, GWP=675)			
		Factory Charging		tCO ₂ e	0.68	0.78	1.49	
				kg	1.00	1.15	2.20	
	Piping	Water Pipe (Space Heating)	Inlet/ Outlet	Φ, mm	28/28	28/28	28/28	
	Operation	Ambient Temperature	Heating	°C	-25-35	-25-35	-25-35	
			Cooling	°C	10-46	10-46	10-46	
			DHW	°C	-25-43	-25-43	-25-43	

Accessories



Touch Controller	Touch Controller	DMS2.5	Wi-Fi Kit	External Room Sensor	Backup Heater (4/6kW)
MWR-WW10*N	MCM-A300N	MIM-D01AN	MIM-H04EN	MRW-TA	MHC-*00FE



AE200RNWMEG/EU AE160RXYDEG/EU MWR-WW10N	AE260RNWMEG/EU AE080RXYDEG/EU MWR-WW10N	AE260RNWMEG/EU AE120RXYDEG/EU MWR-WW10N	AE260RNWMEG/EU AE160RXYDEG/EU MWR-WW10N
16.0/15.0	8.0/7.1	12.0/11.3	16.0/15.0
14.0	7.5	12.0	14.0
3.62/5.18	1.77/2.53	2.65/3.73	3.62/5.18
3.28	1.90	2.77	3.28
4.42/2.90	4.52/2.81	4.53/3.03	4.42/2.90
4.27	3.95	4.33	4.27
4.48/3.53	4.44/3.23	4.69/3.51	4.48/3.53
176/138	175/126	185/138	176/138
A+++ / A++	A+++ / A++	A+++ / A++	A+++ / A++
32.00	22.00	28.00	32.00
40.00	27.50	35.00	40.00
46.2/27.1	23.1/12.8	34.6/20.4	46.2/27.1
15-65	15-65	15-65	15-65
5-25	5-25	5-25	5-25
•	•	•	•
•	•	•	•
•	•	•	•
1Φ, 2, 220-240 V, 50 Hz	1Φ, 2, 220-240 V, 50 Hz	1Φ, 2, 220-240 V, 50 Hz	1Φ, 2, 220-240 V, 50 Hz
200	260	260	260
L	XL	XL	XL
110	123	117	117
A	A	A	A
30	26	30	30
30	26	30	30
44	40	44	44
2 (4/6)	2 (4/6)	2 (4/6)	2 (4/6)
28/28	28/28	28/28	28/28
22/22	22/22	22/22	22/22
130.0	140.0	140.0	140.0
595 x 1,800 x 700	595 x 1,800 x 700	595 x 1,800 x 700	595 x 1,800 x 700
1Φ, 220-240 V, 50 Hz	1Φ, 220-240 V, 50 Hz	1Φ, 220-240 V, 50 Hz	1Φ, 220-240 V, 50 Hz
BLDC Twin Rotary	BLDC Twin Rotary	BLDC Twin Rotary	BLDC Twin Rotary
0.15	0.15	0.15	0.15
52	48	50	52
54	48	50	54
66	63	64	66
110.0	76.0	110.0	110.0
940 x 1,420 x 330	940 x 998 x 330	940 x 1,420 x 330	940 x 1,420 x 330
	R32 (Fluorinated greenhouse gas, GWP=675)		
1.49	0.78	1.49	1.49
2.20	1.15	2.20	2.20
28/28	28/28	28/28	28/28
-25-35	-25-35	-25-35	-25-35
10-46	10-46	10-46	10-46
-25-43	-25-43	-25-43	-25-43



* A+++ energy label is available according to EU No. 811/2013 label classification 2019, on a scale from D to A+++

¹ A2W Condition : (Heating) Water In/Out 30°C/35°C, Outdoor Air 7°C[DB]/6°C[WB]; (Cooling) Water In/Out 23°C/18°C, Outdoor Air 35°C[DB].

² A2W Condition : (Heating) Water In/Out 47°C/55°C, Outdoor Air 7°C[DB]/6°C[WB].

³ 65°C down to +10°C (max. 60°C down to -5°C)

⁴ Sound pressure level is obtained in an anechoic room. Sound pressure level is a relative value, depending on the distance and acoustic environment. Sound pressure level may differ depending on operation conditions.

Specifications

ClimateHub Mono (Continued)

R32

Mono



		Indoor Unit		AE260RNWMGG/EU	AE260RNWMGG/EU	AE260RNWMGG/EU	
		Outdoor Unit		AE080RXYDGG/EU	AE120RXYDGG/EU	AE160RXYDGG/EU	
		Controller		MWR-WW10N	MWR-WW10N	MWR-WW10N	
System	Operation	Nominal Capacity	Heating A7/W35 ¹ / A7/W55 ²	kW	8.0/7.1	12.0/11.3	16.0/15.0
			Cooling A35/W18 ¹	kW	7.5	12.0	14.0
		Power Input (Nominal)	Heating A7/W35 ¹ / A7/W55 ²	kW	1.77/2.53	2.65/3.73	3.62/5.18
			Cooling A35/W18 ¹	kW	1.90	2.77	3.28
		COP (Nominal Heating) A7/W35 ¹ / A7/W55 ²	W/W	4.52/2.81	4.53/3.03	4.42/2.90	
		EER (Nominal Cooling) A35/W18 ¹	W/W	3.95	4.33	4.27	
		SCOP LWT 35°C/ 55°C	W/W	4.44/3.23	4.69/3.51	4.48/3.53	
		Seasonal Space Heating enr. efficiency η _s LWT 35°C/ 55°C	ETA%	175/126	185/138	176/138	
		Seasonal Space Heating Eff. class * LWT 35°C/ 55°C	-		A+++ / A++	A+++ / A++	A+++ / A++
		Current	MCA	A	10.00	10.00	12.00
	MFA		A	16.10	16.10	16.10	
	Water Flow Rate	Low / Medium temperature	l/min	23.1/12.8	34.6/20.4	46.2/27.1	
	Leaving Water Temperature ²	Heating	°C	15-65	15-65	15-65	
		Cooling	°C	5-25	5-25	5-25	
	Functions	Smart Grid Ready / PV Enabled	-	•	•	•	
3-Step Quiet Mode		-	•	•	•		
2-zone Control		-	•	•	•		
Tank Integrated Hydro Unit	Power Supply		Φ, #, V, Hz	3Φ, 4, 380-415 V, 50 Hz	3Φ, 4, 380-415 V, 50 Hz	3Φ, 4, 380-415 V, 50 Hz	
	Water Tank Volume		litres	260	260	260	
	Declared Load Profile		L/XL	XL	XL	XL	
	Average water heating efficiency η _{wh}		ETA%	123	117	117	
	Average Energy Efficiency Class		-	A	A	A	
	Sound	Sound Pressure ⁴	Heating Std	dB(A)	26	30	30
			Cooling Std	dB(A)	26	30	30
	Sound Power	Heating Std	dB(A)	40	44	44	
		Cooling Std	dB(A)	40	44	44	
	Heater	Back-up heater Capacity	Default (Option)	kW	6	6	6
Piping	Water Pipe (Space Heating)	Inlet/ Outlet	Φ, mm	28/28	28/28	28/28	
	Water pipe (DHW)	Inlet/ Outlet	Φ, mm	22/22	22/22	22/22	
Dimensions	Net Weight		kg	140.0	140.0	140.0	
	Net Dimensions (WxHxD)		mm	595 x 1,800 x 700	595 x 1,800 x 700	595 x 1,800 x 700	
Outdoor Unit	Power Supply		Φ, V, Hz	3Φ, 380-415 V, 50 Hz	3Φ, 380-415 V, 50 Hz	3Φ, 380-415 V, 50 Hz	
	Compressor	Type	-	BLDC Twin Rotary	BLDC Twin Rotary	BLDC Twin Rotary	
	Base Heater	Capacity	kW	0.15	0.15	0.15	
	Sound	Sound Pressure ⁴	Heating Std	dB(A)	48	50	52
			Cooling Std	dB(A)	48	50	54
			Heating Std	dB(A)	63	64	66
	Dimensions	Net Weight		kg	75.0	111.0	111.0
		Net Dimensions (WxHxD)		mm	940 x 998 x 330	940 x 1,420 x 330	940 x 1,420 x 330
	Refrigerant	Type			R32 (Fluorinated greenhouse gas, GWP=675)		
		Factory Charging		tCO ₂ e	0.78	1.49	1.49
				kg	1.15	2.20	2.20
	Piping	Water Pipe (Space Heating)	Inlet/ Outlet	Φ, mm	28/28	28/28	28/28
	Operation	Ambient Temperature	Heating	°C	-25-35	-25-35	-25-35
			Cooling	°C	10-46	10-46	10-46
			DHW	°C	-25-43	-25-43	-25-43



* A+++ energy label is available according to EU No. 811/2013 label classification 2019, on a scale from D to A+++

¹ A2W Condition : (Heating) Water In/Out 30°C/35°C, Outdoor Air 7°C[DB]/6°C[WB]; (Cooling) Water In/Out 23°C/18°C, Outdoor Air 35°C[DB].

² A2W Condition : (Heating) Water In/Out 47°C/55°C, Outdoor Air 7°C[DB]/6°C[WB].

³ 65°C down to +10°C (max. 60°C down to -5°C)

⁴ Sound pressure level is obtained in an anechoic room. Sound pressure level is a relative value, depending on the distance and acoustic environment. Sound pressure level may differ depending on operation conditions.

Project: Atico en el Retiro (Spain)
 Project Architecture: ÁBATON
 Interior Design: BATAVIA
 Photography: Belén Imaz

Specifications

Mono with Third Party DHW Tank R32

- Intuitive, colour screen touch controller in multiple languages.
- Energy monitoring through touch controller.
- PV and Smart Grid ready.
- 2-zone Control, suitable for floor heating and radiators.
- SmartThings compatible with optional Wi-Fi kit.
- Backup heater is recommended to ensure a minimum water temperature.



		Outdoor Unit		AE050RXYDEG/EU		AE080RXYDEG/EU		AE120RXYDEG/EU	
		Control Kit		MIM-E03CN		MIM-E03CN		MIM-E03CN	
System	Operation	Nominal Capacity	Heating A7/W35 ¹ / A7/W55 ²	kW	5.0/4.3	8.0/7.1	12.0/11.3		
			Cooling A35/W18 ¹	kW	5.0	7.5	12.0		
		Power Input (Nominal)	Heating A7/W35 ¹ / A7/W55 ²	kW	1.03/1.52	1.77/2.53	2.65/3.73		
			Cooling A35/W18 ¹	kW	1.14	1.90	2.77		
		COP (Nominal Heating) A7/W35 ¹ / A7/W55 ²		W/W	4.85/2.83	4.52/2.81	4.55/3.03		
		EER (Nominal Cooling) A35/W18 ¹		W/W	4.39	3.95	4.33		
		Seasonal space heating enr. efficiency η _s LWT 35°C/ 55°C		ETA%	175/ 125	175/ 126	185/ 138		
		Seasonal space heating eff. class** LWT 35°C/ 55°C		-	A+++ / A++	A+++ / A++	A+++ / A++		
		Current	MCA	A	16.00	22.00	28.00		
			MFA	A	20.00	27.50	35.00		
		Leaving Water Temperature ³	Heating	°C	15-65	15-65	15-65		
			Cooling	°C	5-25	5-25	5-25		
		Functions	Smart Grid Ready / PV Enabled		-	•	•	•	
			3-Step Quiet Mode		-	•	•	•	
2-zone Control			-	•	•	•			
Outdoor Unit	Power Supply		Φ, V, Hz	1Φ, 220-240 V, 50 Hz	1Φ, 220-240 V, 50 Hz	1Φ, 220-240 V, 50 Hz			
	Compressor		Type	-	BLDC Twin Rotary	BLDC Twin Rotary	BLDC Twin Rotary		
	Base Heater		Capacity	kW	-	0.15	0.15		
	Sound	Sound Pressure ⁴	Heating Std	dB(A)	45	48	50		
			Cooling Std	dB(A)	45	48	50		
		Sound Power	Heating Std	dB(A)	61	63	64		
	Dimensions	Net Weight		kg	58.5	76.0	110.0		
		Net Dimensions (WxHxD)		mm	880 x 798 x 310	940 x 998 x 330	940 x 1,420 x 330		
	Piping		Water Pipe	Inlet/ Outlet	Φ, mm	25/ 25	25/ 25	25/ 25	
	Refrigerant		Type		R32 (Fluorinated greenhouse gas, GWP=675)				
			Factory Charging		tCO ₂ e	0.68	0.78	1.49	
					kg	1.00	1.15	2.20	
	Operation	Ambient Temperature		Heating	°C	-25-35	-25-35	-25-35	
				Cooling	°C	10-46	10-46	10-46	
DHW				°C	-25-43	-25-43	-25-43		

Accessories



Mono Control Kit

Touch Controller

DMS2.5

Wi-Fi Kit

External Room Sensor

MIM-E03CN

MCM-A300N

MIM-D01AN

MIM-H04EN

MRW-TA



AE160RXYDEG/EU

AE080RXYDGG/EU

AE120RXYDGG/EU

AE160RXYDGG/EU

MIM-E03CN

MIM-E03CN

MIM-E03CN

MIM-E03CN

16.0/15.0

8.0/7.1

12.0/11.3

16.0/15.0

14.0

7.5

12.0

14.0

3.62/5.18

1.77/2.53

2.65/3.73

3.62/5.18

3.28

1.90

2.77

3.28

4.42/2.90

4.52/2.81

4.53/3.03

4.42/2.90

4.27

3.95

4.33

4.27

176/138

175/126

185/138

176/138

A+++ / A++

A+++ / A++

A+++ / A++

A+++ / A++

32.00

10.00

10.00

12.00

40.00

16.10

16.10

16.10

15-65

15-65

15-65

15-65

5-25

5-25

5-25

5-25

•

•

•

•

•

•

•

•

•

•

•

•

1Φ, 220-240 V, 50 Hz

3Φ, 380-415 V, 50 Hz

3Φ, 380-415 V, 50 Hz

3Φ, 380-415 V, 50 Hz

BLDC Twin Rotary

BLDC Twin Rotary

BLDC Twin Rotary

BLDC Twin Rotary

0.15

0.15

0.15

0.15

52

48

50

52

54

48

50

54

66

63

64

66

110.0

75.0

111.0

111.0

940 x 1,420 x 330

940 x 998 x 330

940 x 1,420 x 330

940 x 1,420 x 330

25/ 25

25/ 25

25/ 25

25/ 25

R32 (Fluorinated greenhouse gas, GWP=675)

1.49

0.78

1.49

1.49

2.20

1.15

2.20

2.20

-25-35

-25-35

-25-35

-25-35

10-46

10-46

10-46

10-46

-25-43

-25-43

-25-43

-25-43



*A+++ energy label is available according to EU No. 811/2013 label classification 2019, on a scale from D to A+++

¹A2W Condition : (Heating) Water In/Out 30°C/35°C, Outdoor Air 7°C[DB]/6°C[WB]; (Cooling) Water In/Out 23°C/18°C, Outdoor Air 35°C[DB].

²A2W Condition : (Heating) Water In/Out 47°C/55°C, Outdoor Air 7°C[DB]/6°C[WB].

³65°C down to +10°C (max. 60°C down to -5°C)

⁴Sound pressure level is obtained in an anechoic room. Sound pressure level is a relative value, depending on the distance and acoustic environment. Sound pressure level may differ depending on operation conditions.

Dimensional Drawings

Mono Tank Integrated Hydro Unit

AE200/260RNW**G/EU

Units: mm

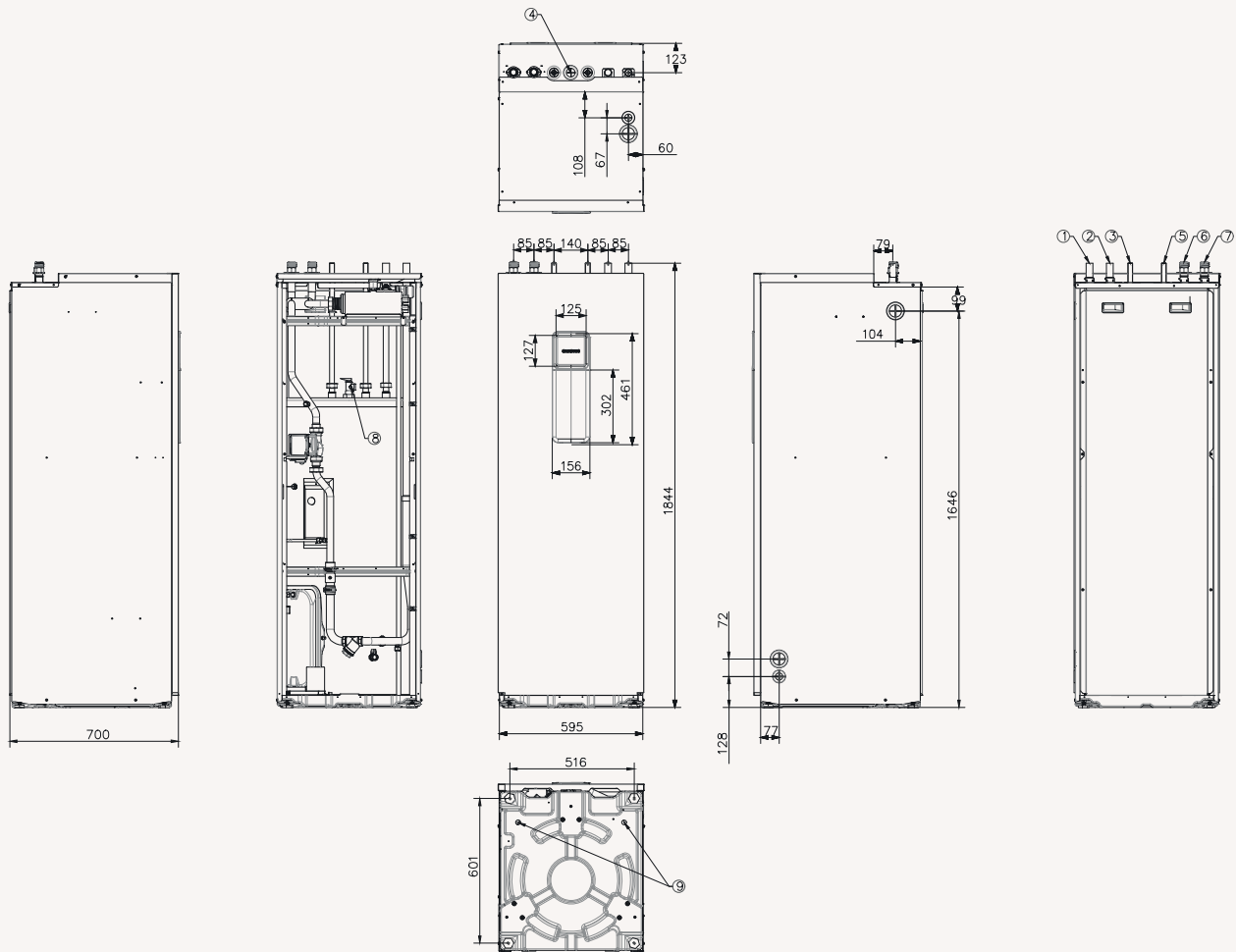

NO	Name	Description	
		AE200RNWMEG/EU	AE260RNWM*G/EU
1	Space heating Inlet	ø28	ø28
2	Space heating Outlet	ø28	ø28
3	DHW Inlet	ø22	ø22
4	Secondary water return	N/A	ø22
5	DHW Outlet	ø22	ø22
6	Heat Pump In	ø28	ø28
7	Heat Pump Out	ø28	ø28
8	T/P v/v	Female PT1/2"	Female PT1/2"
9	Drain Holes	(Option) Connect with the provided drain plug	

Mono Outdoor

AE050RXYDEG/EU

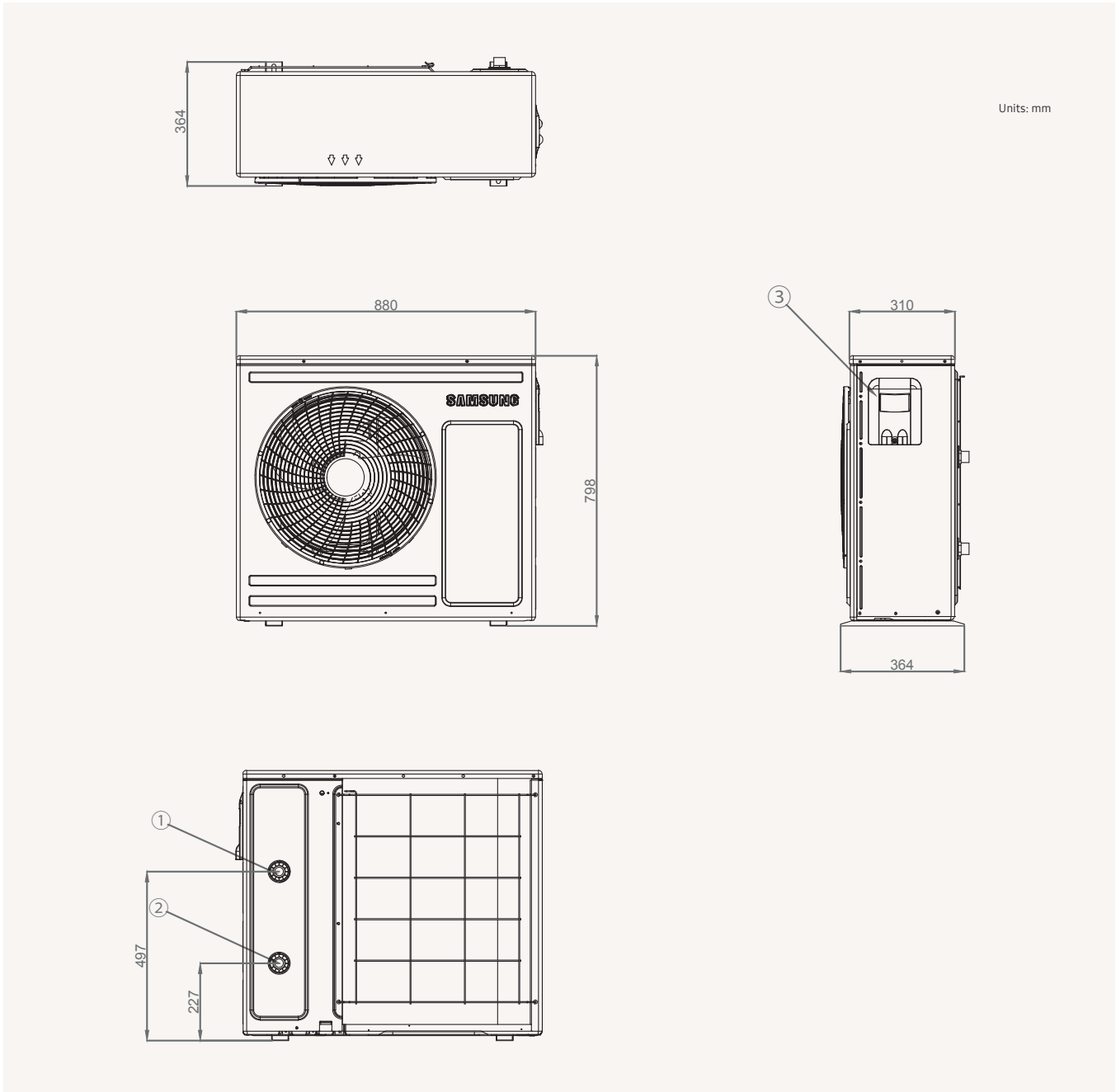

NO	Name	Description
1	Water Pipe(Out)	BSPP male 1"
2	Water Pipe(In)	BSPP male 1"
3	Power & Communication Wiring Conduit Holes	

Dimensional Drawings

Mono Outdoor

AE080RXYD*G/EU

Units: mm [inches]

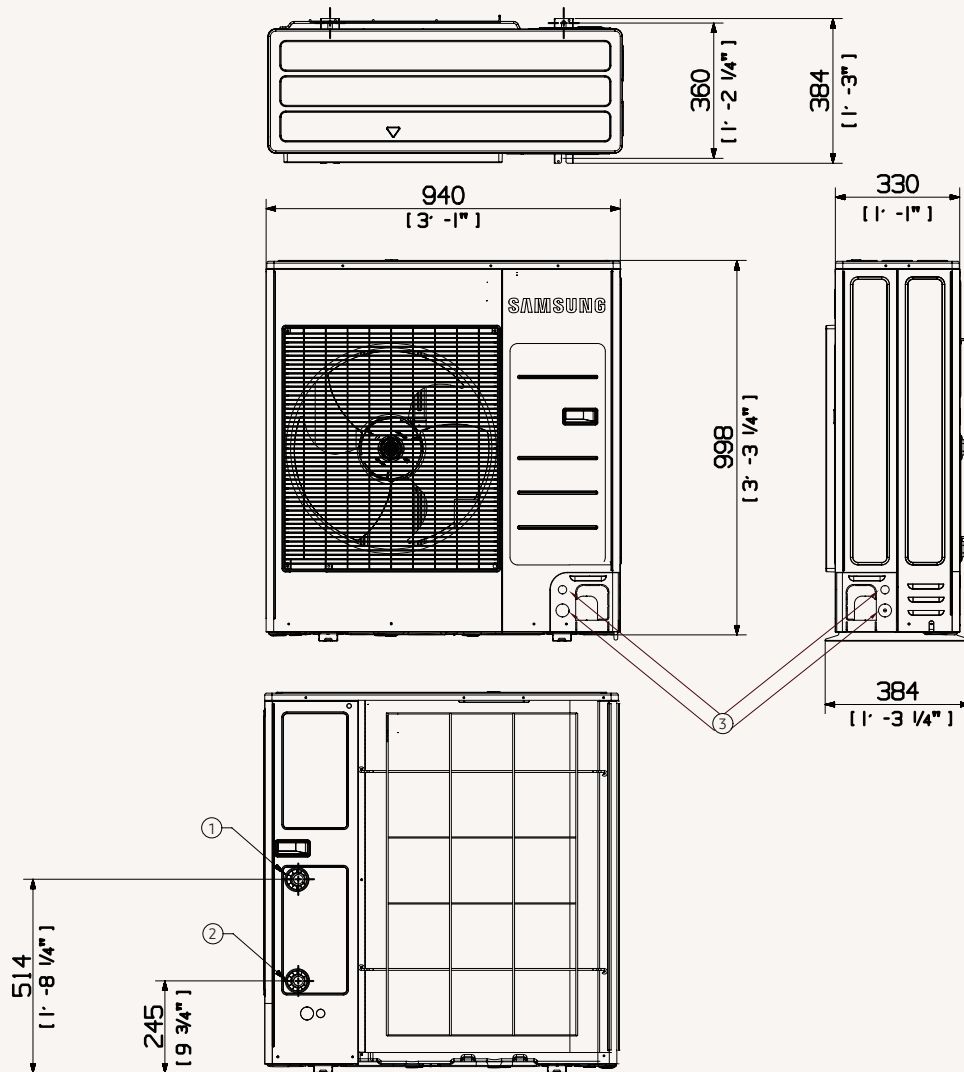

NO	Name	Description
1	Water Pipe(Out)	BSPP male 1"
2	Water Pipe(In)	BSPP male 1"
3	Power & Communication Wiring Conduit Holes	

Mono Outdoor

AE120/160RXYD*G/EU

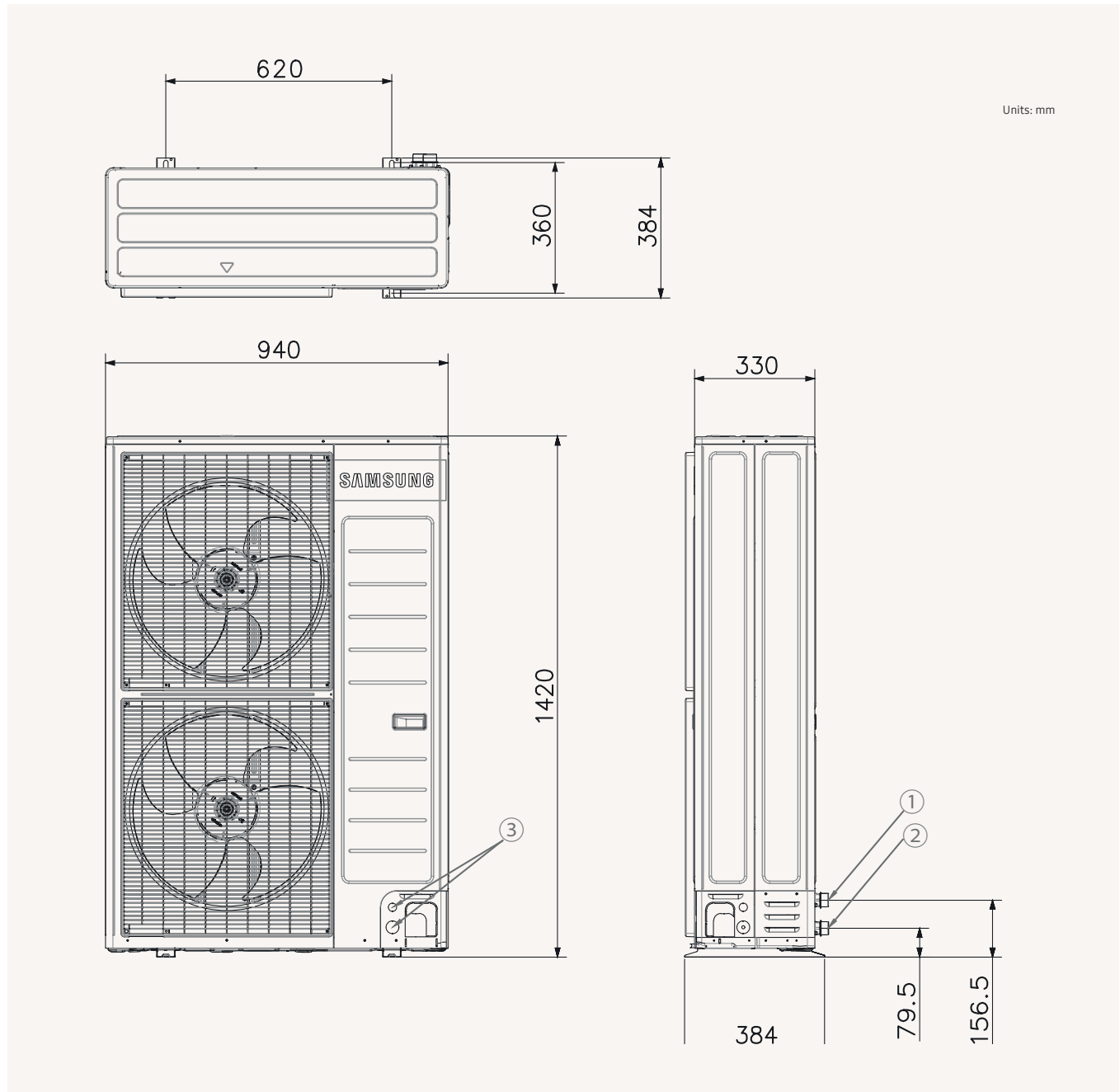

NO	Name	Description
1	Water Pipe(Out)	BSPP male 1"
2	Water Pipe(In)	BSPP male 1"
3	Power & Communication Wiring Conduit Holes	

Dimensional Drawings

Mono Control Kit

MIM-E03CN

Units: mm

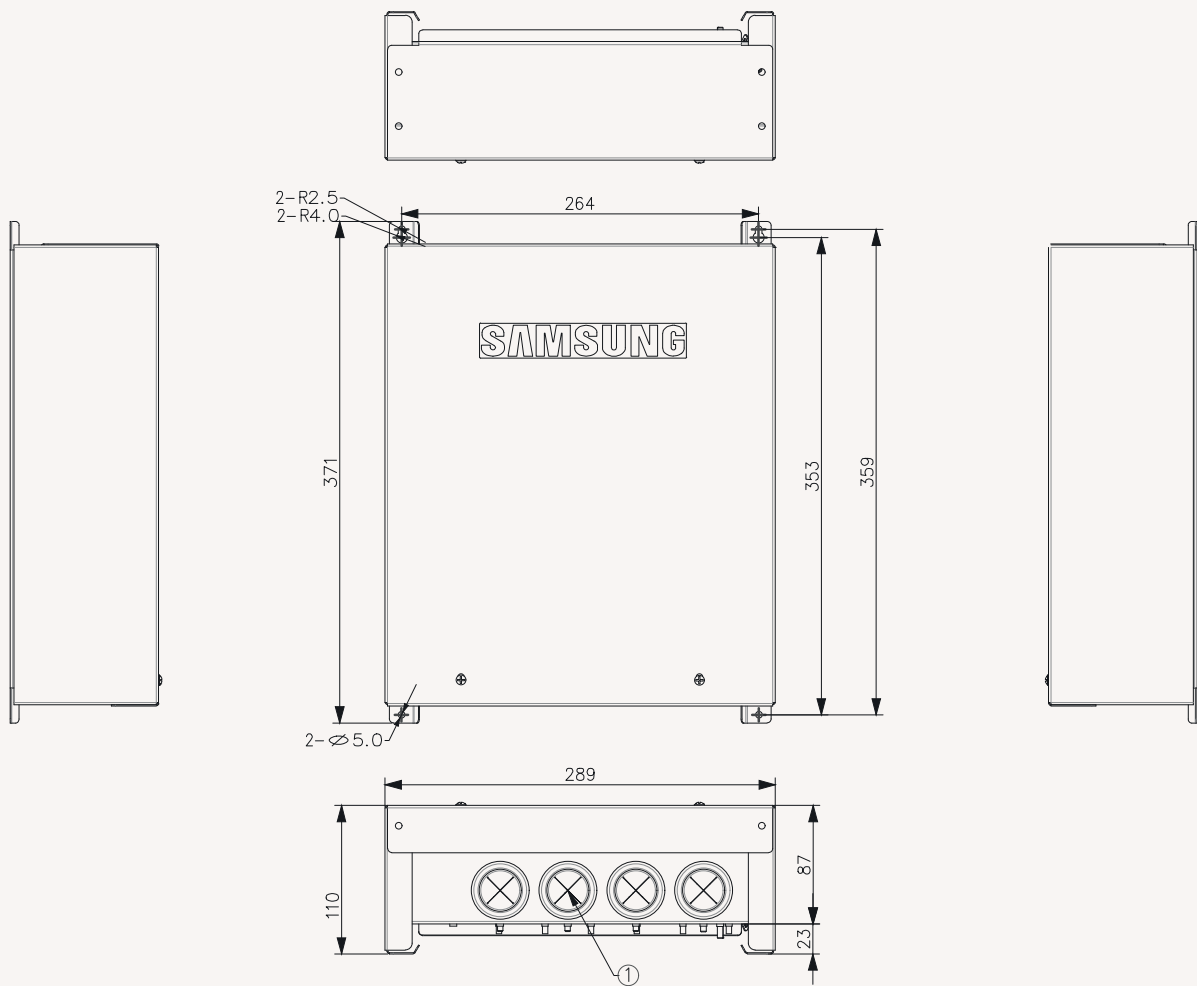

NO	Name
1	Conduit Holes for Wiring (Rubber)

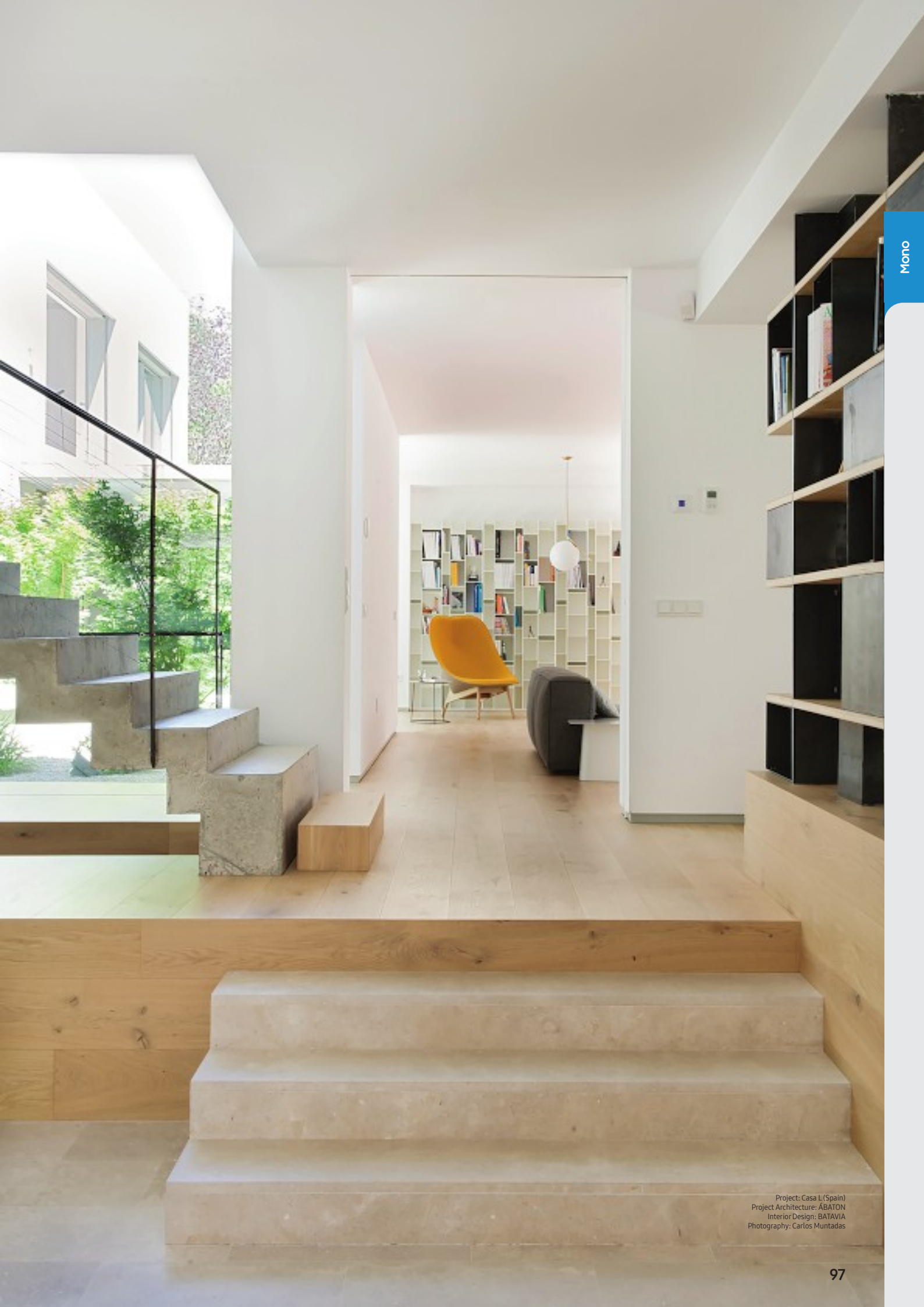

Split



Specifications

ClimateHub Split R32

- Integrated solution for heating and domestic hot water.
- 4-step quiet operation mode (down to 35 db(A)¹).
- Compact unit size with large water tank (200 L & 260 L).
- Backup heater is included to ensure a minimum water temperature.

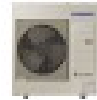

		Indoor Unit		AE200RNWSEG/EU		AE060RXEDEG/EU		AE200RNWSEG/EU		AE090RXEDEG/EU	
		Outdoor Unit		AE200RNWSEG/EU		AE060RXEDEG/EU		AE200RNWSEG/EU		AE090RXEDEG/EU	
		Controller		MWR-WW10N		MWR-WW10N		MWR-WW10N		MWR-WW10N	
System	Operation	Nominal Capacity	Heating A7/W35 ¹ / A7/W55 ²	kW	4.4/3.9	6.0/5.2	9.0/8.0				
			Cooling A35/W18 ¹	kW	5.0	6.5	8.7				
		Power Input (Nominal)	Heating A7/W35 ¹ / A7/W55 ²	kW	0.85/1.32	1.22/1.81	1.87/2.73				
			Cooling A35/W18 ¹	kW	1.09	1.47	2.11				
		COP (Nominal Heating) A7/W35 ¹ / A7/W55 ²	W/W	5.20/2.95	4.92/2.87	4.81/2.93					
		EER (Nominal Cooling) A35/W18 ¹	W/W	4.59	4.42	4.12					
		SCOP LWT 35°C/ 55°C	W/W	4.58/3.25	4.58/3.31	4.45/3.24					
		Seasonal space heating enr. efficiency η _s LWT 35°C/ 55°C	ETA%	180/127	180/129	175/127					
		Average Seasonal space heating eff. class ** LWT 35°C/ 55°C	-		A+++ / A++	A+++ / A++	A+++ / A++				
		Current	MCA	A	16.00	16.00	22.00				
			MFA	A	20.00	20.00	27.50				
		Leaving Water Temperature ³	Heating	°C	15-65	15-65	15-65				
			Cooling	°C	5-25	5-25	5-25				
		Functions	Smart Grid Ready / PV Enabled	-	•	•	•				
			4-Step Quiet Mode	-	•	•	•				
2-zone Control	-		•	•	•						
Tank Integrated Hydro Unit	Power Supply	Φ, #, V, Hz	1Φ, 2, 220-240 V, 50 Hz	1Φ, 2, 220-240 V, 50 Hz	1Φ, 2, 220-240 V, 50 Hz						
	Water Tank Volume	litres	200	200	200						
	Declared Load Profile	L/XL	L	L	L						
	Average water heating efficiency η _{wh}	ETA%	120	120	119						
	Average Energy Efficiency Class		A+	A+	A+						
	Heater	Back-up heater Capacity	Default (Option)	kW	2 (4/6)	2 (4/6)	2 (4/6)				
	Sound	Sound Pressure ⁴	Heating Std	dB(A)	26	26	26				
			Cooling Std	dB(A)	26	26	26				
		Sound Power	Heating Std	dB(A)	40	40	40				
Piping	Water pipe (Space Heating)	Inlet/Outlet	Φ, mm	28/28	28/28	28/28					
	Water pipe (DHW)	Inlet/Outlet	Φ, mm	22/22	22/22	22/22					
Dimensions	Net Weight	kg	136	136	136						
	Net Dimensions (WxHxD)	mm	595 x 1,800 x 700	595 x 1,800 x 700	595 x 1,800 x 700						
Outdoor Unit	Power Supply	Φ, V, Hz	1Φ, 220-240 V, 50 Hz	1Φ, 220-240 V, 50 Hz	1Φ, 220-240 V, 50 Hz						
	Compressor	Type	-	BLDC Twin Rotary	BLDC Twin Rotary	BLDC Twin Rotary					
	Base Heater	Capacity	kW	-	-	0.15					
	Sound	Sound Pressure ⁴	Heating Std	dB(A)	44	47	49				
			Cooling Std	dB(A)	46	47	49				
			Night Mode	dB(A)	<35	35	35				
	Sound Power	Heating Std	dB(A)	58	60	64					
	Dimensions	Net Weight	kg	46.5	46.5	73.0					
		Net Dimensions (WxHxD)	mm	880 x 638 x 310	880 x 638 x 310	940 x 998 x 330					
	Refrigerant	Type	-	R32 (Fluorinated greenhouse gas, GWP=675)							
	Factory Charging		tCO ₂ e	0.81	0.81	0.95					
			kg	1.2	1.2	1.4					
	Piping	Piping Connections	Liquid Pipe	Φ, mm (inch)	6.35 (1/4")	6.35 (1/4")	6.35 (1/4")				
			Gas Pipe	Φ, mm (inch)	15.88 (5/8")	15.88 (5/8")	15.88 (5/8")				
Piping length (ODU-IDU) ⁵		Max. [Equiv.]	m	30.00	30.00	35.00					
Level difference (IDU-IDU) ⁵		Max.	m	20.00	20.00	20.00					
Operation	Ambient Temperature	Heating	°C	-25-35	-25-35	-25-35					
		Cooling	°C	10-46	10-46	10-46					
		DHW	°C	-25-43	-25-43	-25-43					

Accessories



Touch Controller	Touch Controller	DMS2.5	Wi-Fi Kit	External Room Sensor	Backup Heater (4/6kW)
MWR-WW10*N	MCM-A300N	MIM-D01AN	MIM-H04EN	MRW-TA	MHC-*00FE



AE260RNWSEG/EU AE040RXEDEG/EU MWR-WW10N	AE260RNWSEG/EU AE060RXEDEG/EU MWR-WW10N	AE260RNWSEG/EU AE090RXEDEG/EU MWR-WW10N	AE260RNWSGG/EU AE090RXEDGG/EU MWR-WW10N
4.4/3.9	6.0/5.2	9.0/8.0	9.0/8.0
5.0	6.5	8.7	8.7
0.85/1.32	1.22/1.81	1.87/2.73	1.87/2.73
1.09	1.47	2.11	2.11
5.20/2.95	4.92/2.87	4.81/2.93	4.81/2.93
4.59	4.42	4.12	4.12
4.58/3.25	4.58/3.31	4.45/3.24	4.45/3.24
180/127	180/129	175/127	175/127
A+++ / A++	A+++ / A++	A+++ / A++	A+++ / A++
16.00	16.00	22.00	10.00
20.00	20.00	27.50	16.10
15-65	15-65	15-65	15-65
5-25	5-25	5-25	5-25
•	•	•	•
•	•	•	•
•	•	•	•
1Φ, 2, 220-240 V, 50 Hz	1Φ, 2, 220-240 V, 50 Hz	1Φ, 2, 220-240 V, 50 Hz	3Φ, 4, 380-415 V, 50 Hz
260	260	260	260
XL	XL	XL	XL
123	123	123	123
A+	A+	A+	A+
2 (4/6)	2 (4/6)	2 (4/6)	6
26	26	26	26
26	26	26	26
40	40	40	40
28/28	28/28	28/28	28/28
22/22	22/22	22/22	22/22
146.0	146.0	146.0	146.0
595 x 1,800 x 700	595 x 1,800 x 700	595 x 1,800 x 700	595 x 1,800 x 700
1Φ, 220-240 V, 50 Hz	1Φ, 220-240 V, 50 Hz	1Φ, 220-240 V, 50 Hz	3Φ, 380-415 V, 50 Hz
BLDC Twin Rotary	BLDC Twin Rotary	BLDC Twin Rotary	BLDC Twin Rotary
-	-	0.15	0.15
44	47	49	49
46	47	49	49
<35	35	35	35
58	60	64	64
46.5	46.5	73.0	72.0
880 x 638 x 310	880 x 638 x 310	940 x 998 x 330	940 x 998 x 330
	R32 (Fluorinated greenhouse gas, GWP=675)		
0.81	0.81	0.95	0.95
1.2	1.2	1.4	1.4
6.35 (1/4")	6.35 (1/4")	6.35 (1/4")	6.35 (1/4")
15.88 (5/8")	15.88 (5/8")	15.88 (5/8")	15.88 (5/8")
30.00	30.00	35.00	35.00
20.00	20.00	20.00	20.00
-25-35	-25-35	-25-35	-25-35
10-46	10-46	10-46	10-46
-25-43	-25-43	-25-43	-25-43



*35dB(A) is only applicable for 6kW and 9kW outdoor units down to +4°C stated in 3 m distance in an anechoic environment.

**A+++ energy label is available according to EU No. 811/2013 label classification 2019, on a scale from D to A+++

¹A2W Condition : (Heating) Water In/Out 30°C/35°C, Outdoor Air 7°C[DB]/6°C[WB]; (Cooling) Water In/Out 23°C/18°C, Outdoor Air 35°C[DB].

²A2W Condition : (Heating) Water In/Out 47°C/55°C, Outdoor Air 7°C[DB]/6°C[WB].

³65°C down to +10°C (max. 60°C down to -5°C)

⁴Sound pressure level is obtained in an anechoic room. Sound pressure level is a relative value, depending on the distance and acoustic environment. Sound pressure level may differ depending on operation conditions.

⁵ODU : Outdoor Unit, IDU : Indoor Unit

Specifications

Split with Third Party DHW Tank R32

- Connectable with R32 Split Outdoor Unit in combination of third party Tank.
- Compatible with thermostats, solar panels and back-up boilers.
- Intuitive, colour screen touch controller in multiple languages.
- Energy monitoring through touch controller.
- PV and Smart Grid ready.
- 2-zone Control, suitable for floor heating and radiators.
- SmartThings compatible with optional Wi-Fi kit.
- Backup heater is included to ensure a minimum water temperature.



		Indoor Unit		AE090RNYDEG/EU		AE090RNYDEG/EU		AE090RNYDEG/EU	
		Outdoor Unit		AE040RXEDEG/EU		AE060RXEDEG/EU		AE090RXEDEG/EU	
System	Operation	Nominal Capacity	Heating A7/W35 ¹ / A7/W55 ²	kW	4.4/3.9	6.0/5.2	9.0/8.0		
			Cooling A35/W18 ¹	kW	5.0	6.5	8.7		
		Power Input (Nominal)	Heating A7/W35 ¹ / A7/W55 ²	kW	0.85/1.32	1.22/1.81	1.87/2.73		
			Cooling A35/W18 ¹	kW	1.09	1.47	2.11		
		COP (Nominal Heating) A7/W35 ¹	W/W	5.20/2.95	4.92/2.87	4.81/2.93			
		EER (Nominal Cooling) A35/W18 ¹	W/W	4.59	4.42	4.12			
		Seasonal space heating enr. efficiency η _s LWT 35°C / 55°C	ETA%	180/127	180/129	175/127			
		Seasonal Space Heating Eff. Class LWT 35°C / 55°C	-		A+++ / A++	A+++ / A++	A+++ / A++		
		Current	MCA	A	16.00	16.00	22.00		
			MFA	A	20.00	20.00	27.50		
	Leaving Water Temperature ²	Heating	°C	15-65	15-65	15-65			
		Cooling	°C	5-25	5-25	5-25			
	Functions	Smart Grid Ready / PV Enabled	-	•	•	•			
		4-Step Quiet Mode	-	•	•	•			
2-zone Control		-	•	•	•				
Wall-Mounted Hydro Unit	Power Supply		Φ, #, V, Hz	1Φ, 2, 220-240 V, 50 Hz	1Φ, 2, 220-240 V, 50 Hz	1Φ, 2, 220-240 V, 50 Hz			
	Heater	Back-up heater Capacity	Default (Option)	kW	4	4	4		
	Sound	Sound Pressure ³	Heating Std	dB(A)	26	26	26		
			Cooling Std	dB(A)	26	26	26		
	Sound Power	Heating Std	dB(A)	40	40	40			
			kg	45,0	45,0	45,0			
	Dimensions	Net Weight		kg	45,0	45,0	45,0		
	Net Dimensions (WxHxD)		mm	510 x 850 x 315	510 x 850 x 315	510 x 850 x 315			
Piping	Water pipe	Inlet/Outlet	Φ, inch	1+1/4"	1+1/4"	1+1/4"			
Outdoor unit	Compressor	Type	-	BLDC Twin Rotary	BLDC Twin Rotary	BLDC Twin Rotary			
	Base Heater	Capacity	kW	-	-	0.15			
	Sound	Sound Pressure ³	Heating Std	dB(A)	44	47	49		
			Cooling Std	dB(A)	46	47	49		
			Sound Power	Heating Std	dB(A)	58	60	64	
	Dimensions	Net Weight	kg	46.5	46.5	73.0			
		Net Dimensions (WxHxD)	mm	880 x 638 x 310	880 x 638 x 310	940 x 998 x 330			
	Refrigerant	Type			R32 (Fluorinated greenhouse gas, GWP=675)				
		Factory Charging		tCO ₂ e	1.2	1.2	1.4		
				kg	0.81	0.81	0.95		
		Piping	Piping Connections	Liquid Pipe	Φ, mm (inch)	6.35 (1/4")	6.35 (1/4")	6.35 (1/4")	
	Gas Pipe			Φ, mm (inch)	15.88 (5/8")	15.88 (5/8")	15.88 (5/8")		
	Piping length (ODU-IDU) ⁴		Max. [Equiv.]	m	30	30	35		
	Level difference (IDU-IDU) ⁴		Max.	m	20	20	20		
Chargeless Length			Φ, mm	15	15	15			
Operation	Ambient Temperature	Heating	°C	-25-35	-25-35	-25-35			
		Cooling	°C	10-46	10-46	10-46			
		DHW	°C	-25-43	-25-43	-25-43			

Accessories



Touch Controller (included)

Touch Controller

DMS2.5

Wi-Fi Kit

External Room Sensor

MWR-WW10N

MCM-A300N

MIM-D01AN

MIM-H04EN

MRW-TA



AE090RNYDGG/EU

AE090RXEDGG/EU

9.0/8.0

8.7

1.87/2.73

2.11

4.81/2.93

4.12

175/127

A+++ / A++

10.00

16.10

15-65

5-25

•

•

•

3Φ, 2, 380-415 V, 50 Hz

6

26

26

40

46.5

510 x 850 x 315

1+1/4"

BLDC Twin Rotary

0.15

49

49

64

72.0

940 x 998 x 330

R32 (Fluorinated greenhouse gas,
GWP=675)

1.4

0.95

6.35 (1/4")

15.88 (5/8")

35

20

15

-25-35

10-46

-25-43



*A+++ energy label is available according to EU No. 811/2013 label classification 2019, on a scale from D to A+++

¹A2W Condition : (Heating) Water In/Out 30°C/35°C, Outdoor Air 7°C[DB]/6°C[WB]; (Cooling) Water In/Out 23°C/18°C, Outdoor Air 35°C[DB].

²A2W Condition : (Heating) Water In/Out 47°C/55°C, Outdoor Air 7°C[DB]/6°C[WB].

³Sound pressure level is obtained in an anechoic room. Sound pressure level is a relative value, depending on the distance and acoustic environment. Sound pressure level may differ depending on operation conditions.

⁴ODU : Outdoor Unit, IDU : Indoor Unit

Specifications

Split with Third Party DHW Tank (R410A)

- Connectable with R410A Split Outdoor Unit in combination with a third party Tank.
- Compatible with room thermostats, solar pumps, 2- or 3-way valves and back-up boilers.



		Indoor Unit		AE160ANYDEH/EU		AE160ANYDGH/EU		AE160ANYDEH/EU	
		Outdoor Unit		AE120AXEDEH/EU		AE120AXEDGH/EU		AE160AXEDEH/EU	
System	Operation	Nominal Capacity	Heating A7/W35 ¹ / A7/W55 ²	kW	12.00/ 11.00	12.00/ 11.00	16.00/ 14.60		
			Cooling A35/W18 ¹	kW	12.00	12.00	15.00		
	Power Input (Nominal)	Heating A7/W35	kW	2.59	2.59	3.76			
			Cooling A35/W18 ¹	kW	3.10	3.10	4.14		
		COP (Nominal Heating) A7/W35 ¹ / A7/W55 ²	W/W	4.63/ 2.89	4.63/ 2.89	4.26/ 2.74			
		EER (Nominal Cooling) A35/W18 ¹	W/W	3.87	3.87	3.62			
		SCOP LWT 35°C/ 55°C	W/W	4.59/ 3.12	4.59/ 3.12	4.46/ 3.09			
		Seasonal space heating enr. efficiency η _s LWT 35°C/ 55°C	ETA%	181/ 122	181/ 122	175/ 121			
		Seasonal Space Heating Eff. Class LWT 35°C/ 55°C	-	A+++ / A+	A+++ / A+	A+++ / A+			
		Water flow rate	Low 35°C temp	U/min	35.0	35.0	46.0		
		Current	MCA	A	28	10	32		
			MFA	A	35.0	16.1	40.0		
		Leaving Water Temperature	Heating	°C	15-55	15-55	15-55		
			Cooling	°C	5-25	5-25	5-25		
		Functions	Smart Grid Ready/PV Enabled	-	•	•	•		
	3-Step Quiet Mode		-	•	•	•			
	2-zone Control		-	•	•	•			
Wall-Mounted Hydro Unit	Power Supply		Φ, #, V, Hz	1Φ, 2, 220-240 V, 50 Hz	3Φ, 2, 380-415 V, 50 Hz	1Φ, 2, 220-240 V, 50 Hz			
	Heater	Capacity	kW	6	6	6			
	Sound	Sound Pressure ²	Heating Std	dB(A)	30	30	30		
			Cooling Std	dB(A)	30	30	30		
		Sound Power	Heating Std	dB(A)	44	44	44		
	Piping	Water pipe	Inlet/Outlet	Φ, inch	1+1/4"	1+1/4"	1+1/4"		
	Dimensions	Net Weight		kg	45.0	46.5	45.0		
Net Dimensions (WxHxD)			mm	510 x 850 x 315	510 x 850 x 315	510 x 850 x 315			
Outdoor unit	Compressor	Type	-	BLDC Twin Rotary	BLDC Twin Rotary	BLDC Twin Rotary			
	Base Heater	Capacity	kW	0.15	0.15	0.15			
	Sound	Sound Pressure ²	Heating Std	dB(A)	50	50	52		
			Cooling Std	dB(A)	50	50	54		
			Heating Std	dB(A)	64	64	66		
	Dimensions	Net Weight		kg	100.5	109.0	100.5		
		Net Dimensions (WxHxD)		mm	940 x 1,420 x 330	940 x 1,420 x 330	940 x 1,420 x 330		
	Refrigerant	Type			R410A (Fluorinated greenhouse gas, GWP=2,088)				
		Factory Charging		tCO ₂ e	6.22	6.22	6.22		
				kg	2.98	2.98	2.98		
	Piping	Piping Connections	Liquid Pipe	Φ, mm (inch)	9.52 (3/8")	9.52 (3/8")	9.52 (3/8")		
			Gas Pipe	Φ, mm (inch)	15.88 (5/8")	15.88 (5/8")	15.88 (5/8")		
		Piping length (ODU-IDU) ¹	Max. [Equiv.]	m	50	50	50		
		Level difference (IDU-IDU) ¹	Max.	m	30	30	30		
		Chargeless Length		Φ, mm	15	15	15		
Operation	Ambient Temperature	Heating	°C	-25-35	-25-35	-25-35			
		Cooling	°C	10-46	10-46	10-46			
		DHW	°C	-25-43	-25-43	-25-43			

Accessories



Touch Controller (included)

Touch Controller

DMS2.5

Wi-Fi Kit

External Room Sensor

MWR-WW10N

MCM-A300N

MIM-D01AN

MIM-H04EN

MRW-TA



AE160ANYDGH/EU

AE160AXEDGH/EU

16.00/14.60

15.00

3.76

4.14

4.26/ 2.74

3.62

4.46/ 3.09

175/121

A+++ / A+

46.0

12

16.1

15-55

5-25

•

•

•

3Φ, 2, 380-415 V, 50 Hz

6

30

30

44

1+1/4"

46.5

510 x 850 x 315

BLDC Twin Rotary

0.15

52

54

66

109.0

940 x 1,420 x 330

R410A (Fluorinated greenhouse gas, GWP=2,088)

6.22

2.98

9.52 (3/8")

15.88 (5/8")

50

30

15

-25-35

10-46

-25-43



¹ A2W Condition : (Heating) Water In/Out 30°C/35°C, Outdoor Air 7°C[DB]/6°C[WB]; (Cooling) Water In/Out 23°C/18°C, Outdoor Air 35°C[DB].

² A2W Condition : (Heating) Water In/Out 47°C/55°C, Outdoor Air 7°C[DB]/6°C[WB].

³ Sound pressure level is obtained in an anechoic room. Sound pressure level is a relative value, depending on the distance and acoustic environment. Sound pressure level may differ depending on operation conditions.

⁴ ODU: Outdoor Unit, IDU: Indoor Unit

Split Outdoor

AE040/060RXEDEG/EU

Units: mm

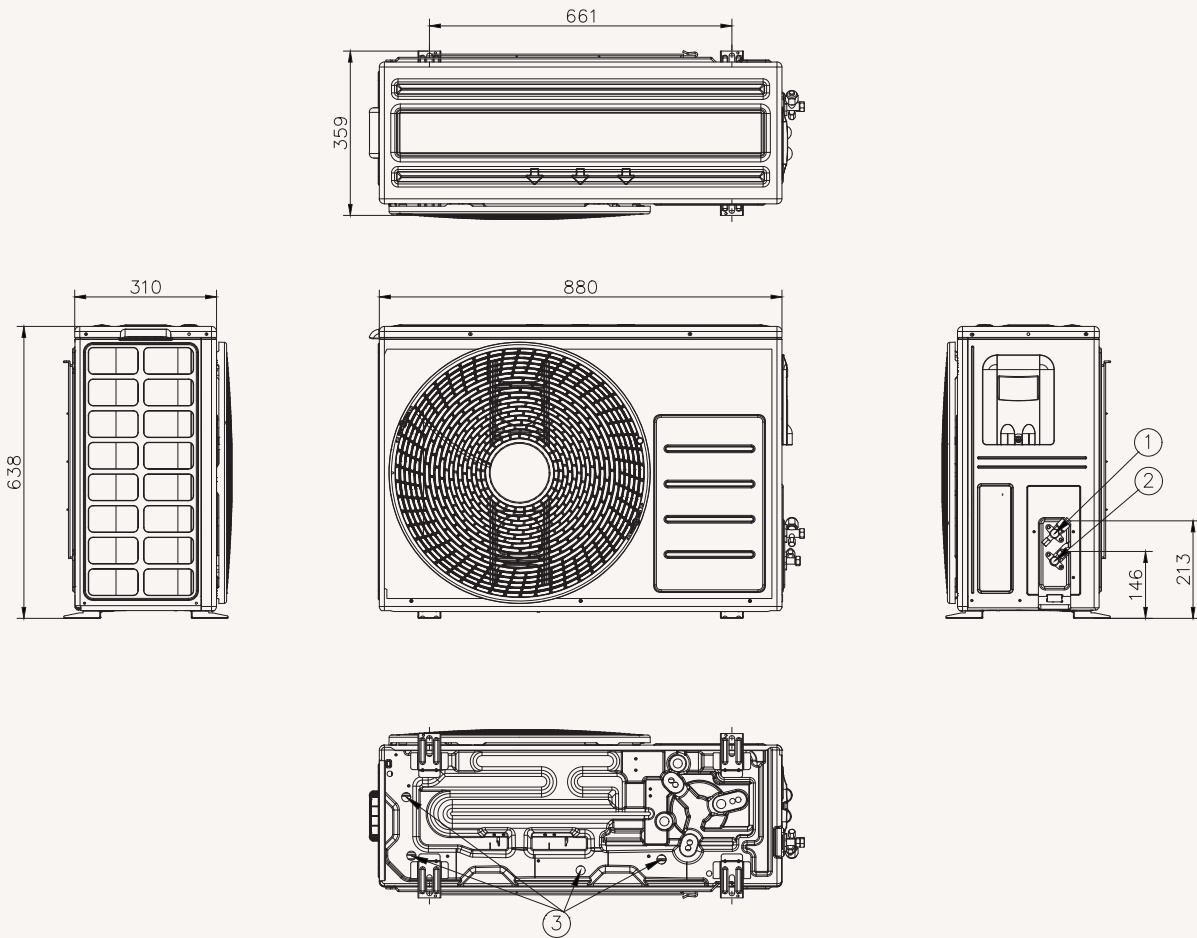

NO	Name	Description
1	Refrigerant liquid pipe	Φ6.35(1/4)
2	Refrigerant gas pipe	Φ15.88(5/8)
3	Drain holes	Connect with the provided drain plug.

Dimensional Drawings

Split Outdoor

AE090RXED*G/EU

Units: mm

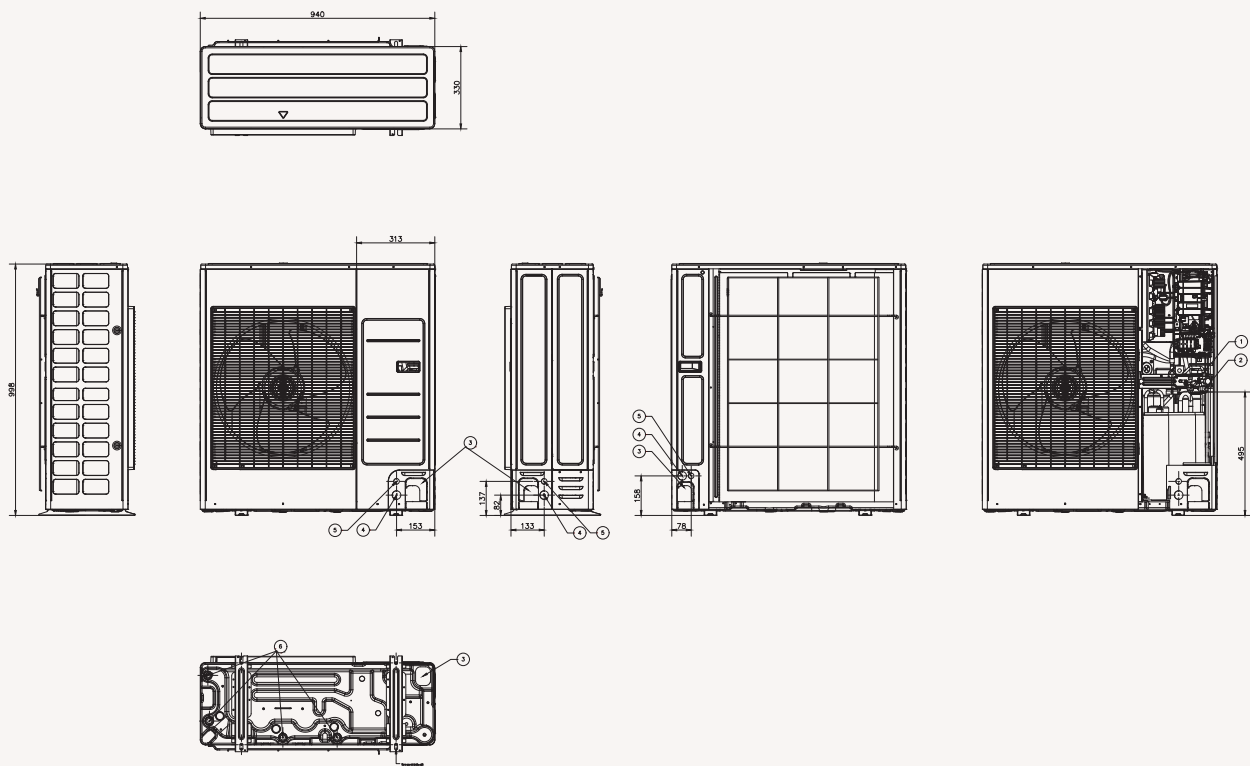

NO	Name	Description
1	Refrigerant gas pipe	$\Phi 6.35(1/4)$
2	Refrigerant liquid pipe	$\Phi 15.88(5/8)$
3	Piping intake knockout hole	Front / Side / Rear / Bottom
4	Power wiring conduit	Front / Side / Rear, $\Phi 34 [1-3/8]$
5	Communication wiring conduit	Front / Side / Rear, $\Phi 22 [7/8]$
6	Drain Hole	Connect with the provided drain plug

Split Outdoor

AE120/160AXED*H/EU

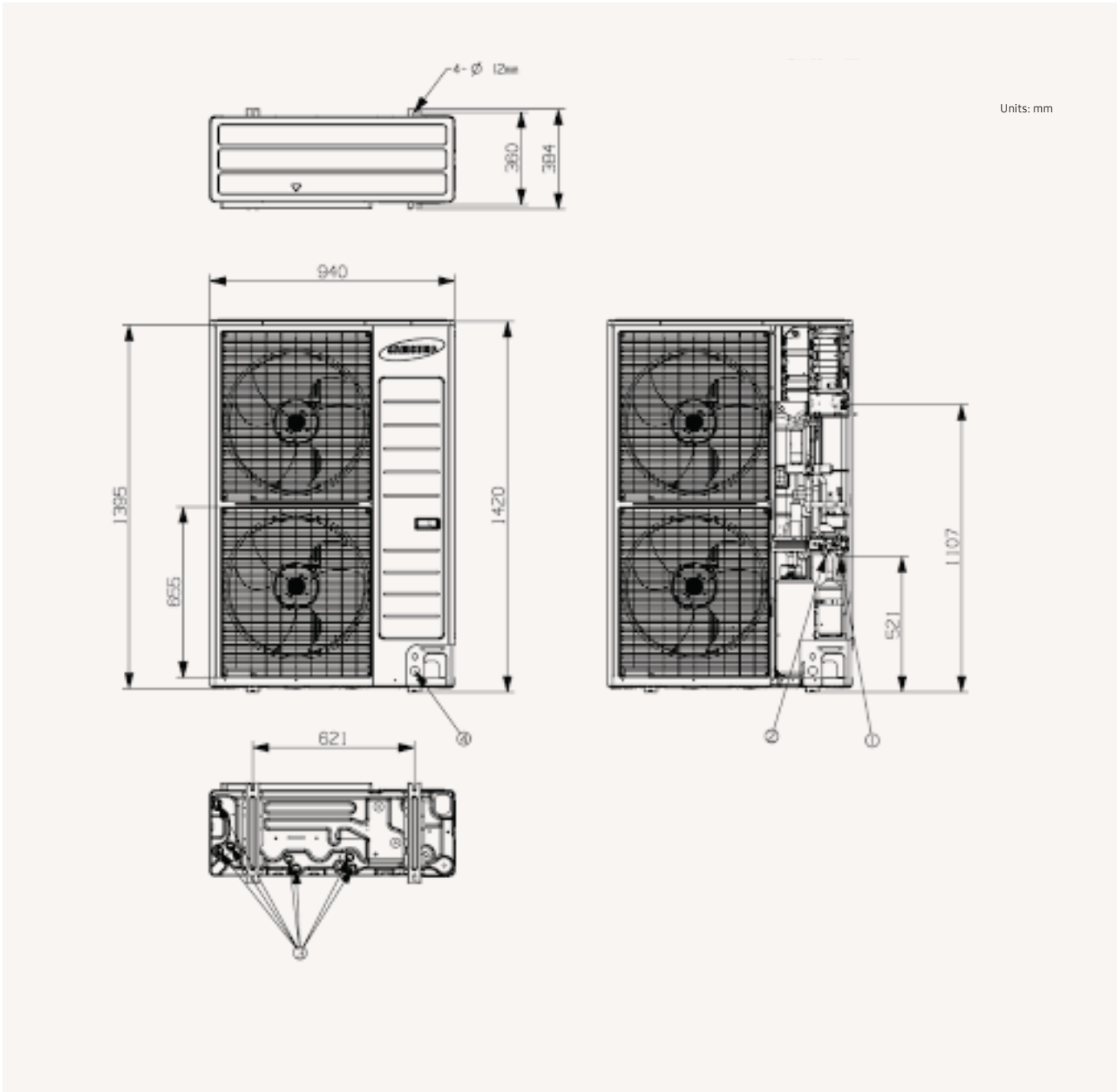

NO	Name	Description
1	Refrigerant gas pipe	φ 15.88
2	Refrigerant liquid pipe	φ 9.52
3	Drain Hole	Connect with the provided drain plug
4	Power wiring conduit	N/A

Dimensional Drawings

Split Wall-Mounted Hydro Unit

AE160ANYD*H/EU

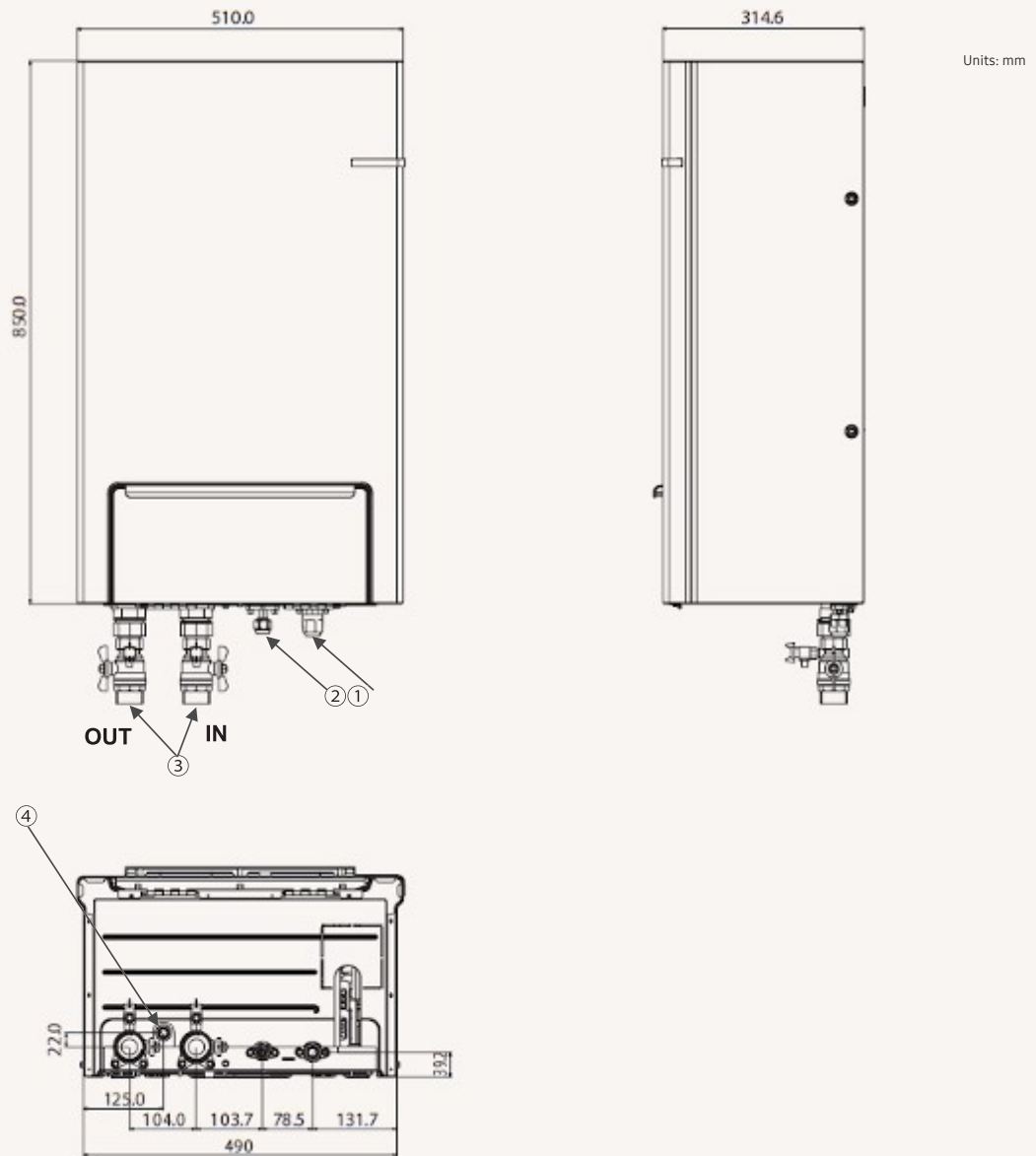

NO	Name	Description
1	Refrigerant gas pipe	Ø15.88
2	Refrigerant liquid pipe	Ø9.52
3	Water pipe inlet/outlet	-
4	Drain Hose Connector	-





TDM Plus

TDM Plus





Specifications

ClimateHub TDM Plus (R410A)

- 'All in one' Air-to-Water and Air-to-Air system.
- PV and Smart Grid ready.
- Compact unit size with large water tank (200L & 260L).
- 2-zone control, suitable for floor heating and radiators.
- Intuitive, colour screen touch controller in multiple languages.
- SCOP rating of A+++**.
- Energy monitoring through touch controller.
- SmartThings compatible with optional Wi-Fi kit.
- Smooth servicing through the front-mounted service window.
- Backup heater is included to ensure a minimum water temperature.



		Indoor Unit		Outdoor Unit		Controller		AE200TNWTEH/EU	AE200TNWTEH/EU
								AE044MXTPEH/EU	AE066MXTPEH/EU
								MWR-WW10N	MWR-WW10N
System	Operation	Nominal Capacity	Heating A7/W35 ¹ / A7/W55 ²	kW	4.4/ 3.8		6.6/ 4.8		
			Cooling A35/W18 ¹	kW	5.1		6.7		
		Power Input (Nominal)	Heating A7/W35 ¹ / A7/W55 ²	kW	0.93/ 1.37		1.47/ 1.85		
			Cooling A35/W18 ¹	kW	1.03		1.48		
		COP (Nominal Heating) A7/W35 ¹ / A7/W55 ²	W/W	4.73/ 2.80		4.49/ 2.59			
		EER (Nominal Cooling) A35/W18 ¹	W/W	4.95		4.53			
		SCOP LWT 35°C/ 55°C	W/W	4.41/ 2.83		4.41/ 2.96			
		Seasonal space heating enr. efficiency η _s LWT 35°C/ 55°C	ETA%	173/ 110		173/ 115			
		Average Seasonal space heating eff. class ** LWT 35°C/ 55°C	-	A++ / A+		A++ / A+			
		Current	MCA	A	18.00		20.00		
			MFA	A	25.00		25.00		
		Maximum allowable IDU ⁵ connections (Hydro A2W unit not included)	Max. number of IDU ⁵	EA	2		3		
			Total capacity Min. (Cooling)	kW	2.20		3.30		
		Leaving Water Temperature ³	Total capacity Min. (Cooling)	kW	4.40		6.60		
			Heating	°C	15-55		15-55		
Functions	Cooling	°C	5-25		5-25				
	Smart Grid Ready / PV Enabled	-	•		•				
	3-Step Quiet Mode	-	•		•				
	2-zone Control	-	•		•				
Tank Integrated Hydro Unit	Power Supply		Φ, #, V, Hz	1Φ, 2, 220-240 V, 50 Hz		1Φ, 2, 220-240 V, 50 Hz			
	Water Tank Volume		litres	200		200			
	Declared Load Profile		L/XL	L		L			
	Average water heating efficiency η _{wh}		ETA%	115		115			
	Average Energy Efficiency Class		-	A+		A+			
	Heater	Back-up heater Capacity	Default (Option)	kW	2 (4/6)		2 (4/6)		
	Sound	Sound Pressure ⁴	Heating Std	dB(A)	29		29		
			Cooling Std	dB(A)	29		29		
		Sound Power	Heating Std	dB(A)	43		43		
	Piping	Water pipe (Space Heating)	Inlet/Outlet	Φ, inch	1+1/4"		1+1/4"		
Dimensions	Net Weight		kg	137		137			
	Net Dimensions (WxHxD)		mm	595 x 1,800 x 700		595 x 1,800 x 700			
Outdoor Unit	Power Supply		Φ, V, Hz	1Φ, 2, 220-240 V, 50 Hz		1Φ, 2, 220-240 V, 50 Hz			
	Compressor	Type	-	Rotary Comp		Rotary Comp			
	Base Heater	Capacity	kW	-		-			
	Sound	Sound Pressure ⁴	Heating Std	dB(A)	47		48		
			Cooling Std	dB(A)	46		47		
		Sound Power	Heating Std	dB(A)	65		67		
	Dimensions	Net Weight		kg	61.0		61.0		
		Net Dimensions (WxHxD)		mm	880 x 793 x 310		880 x 793 x 310		
	Refrigerant	Type		Type	R410A (Fluorinated greenhouse gas, GWP=2,088)		R410A (Fluorinated greenhouse gas, GWP=2,088)		
		Factory Charging		tCO ₂ e	5.43		5.43		
	Piping	Piping Connections	Liquid Pipe	Φ, mm (inch)	9.52 (3/8")		9.52 (3/8")		
			Gas Pipe	Φ, mm (inch)	15.88 (5/8")		15.88 (5/8")		
		Piping length (ODU-IDU) ⁵	Max.[Equiv.]	m	30		30		
		Level difference (IDU-IDU) ⁵	Max.	m	20		20		
		Chargeless length		m	10		10		
	Operation	Ambient Temperature A2W	Heating	°C	-25-35		-25-35		
			Cooling	°C	10-46		10-46		
			DHW	°C	-25-43		-25-43		
Ambient Temperature A2A		Heating	°C	-25-24		-25-24			
		Cooling	°C	10-46		10-46			

Accessories



Touch Controller	Touch Controller	DMS2.5	Wi-Fi Kit	External Room Sensor	Backup Heater (4/6kW)
MWR-WW10*N	MCM-A300N	MIM-D01AN	MIM-H04EN	MRW-TA	MHC-*00FE



AE200TNWTEH/EU AE090MXTPEH/EU MWR-WW10N	AE200TNWTEH/EU AE090MXTPGH/EU MWR-WW10N	AE260TNWTEH/EU AE044MXTPEH/EU MWR-WW10N	AE260TNWTEH/EU AE066MXTPEH/EU MWR-WW10N
9.0/ 7.7	9.0/ 7.7	4.4/ 3.8	6.6/ 4.8
8.0	8.0	5.1	6.7
2.12/ 2.82	2.12/ 2.82	0.93/ 1.37	1.47/ 1.85
1.85	1.86	1.03	1.48
4.25/ 2.72	4.25/ 2.69	4.73/ 2.80	4.49/ 2.59
4.32	4.30	4.95	4.53
4.42/ 3.01	4.44/ 2.86	4.41/ 2.83	4.41/ 2.96
174/ 117	175/ 111	173/ 110	173/ 115
A++ / A+	A+++ / A+	A++ / A+	A++ / A+
22.00	10.00	18.00	20.00
27.50	16.10	25.00	25.00
4	4	2	3
4.50	4.50	2.20	3.30
9.00	9.00	4.40	6.60
15-55	15-55	15-55	15-55
5-25	5-25	5-25	5-25
•	•	•	•
•	•	•	•
•	•	•	•
1Φ, 2, 220-240 V, 50 Hz	1Φ, 2, 220-240 V, 50 Hz	1Φ, 2, 220-240 V, 50 Hz	1Φ, 2, 220-240 V, 50 Hz
200	200	260	260
L	L	XL	XL
115	115	105	105
A+	A+	A	A
2 (4/6)	2 (4/6)	2 (4/6)	2 (4/6)
29	29	29	29
29	29	29	29
43	43	43	43
1+1/4"	1+1/4"	1+1/4"	1+1/4"
137	137	147	147
595 x 1,800 x 700	595 x 1,800 x 700	595 x 1,800 x 700	595 x 1,800 x 700
1Φ, 2, 220-240 V, 50 Hz	3Φ, 4, 380-415 V, 50 Hz	1Φ, 2, 220-240 V, 50 Hz	1Φ, 2, 220-240 V, 50 Hz
Rotary Comp	Rotary Comp	Rotary Comp	Rotary Comp
-	-	-	-
51	51	47	48
50	50	46	47
69	69	65	67
74.0	76.0	61.0	61.0
940 x 998 x 330	940 x 998 x 330	880 x 793 x 310	880 x 793 x 310
R410A (Fluorinated greenhouse gas, GWP=2,088)			
5.01	5.01	5.43	5.43
2.4	2.4	2.6	2.6
9.52 (3/8")	9.52 (3/8")	9.52 (3/8")	9.52 (3/8")
15.88 (5/8")	15.88 (5/8")	15.88 (5/8")	15.88 (5/8")
30	30	30	30
20	20	20	20
10	10	10	10
-25-35	-25-35	-25-35	-25-35
10-46	10-46	10-46	10-46
-25-43	-25-43	-25-43	-25-43
-25-24	-25-24	-25-24	-25-24
10-46	10-46	10-46	10-46



*35dB(A) is only applicable for 6kW and 9kW outdoor units down to +4°C stated in 3 m distance in an anechoic environment.

**A+++ energy label is available according to EU No. 811/2013 label classification 2019, on a scale from D to A+++

¹A2W Condition : (Heating) Water In/Out 30°C/35°C, Outdoor Air 7°C[DB]/6°C[WB]; (Cooling) Water In/Out 23°C/18°C, Outdoor Air 35°C[DB].

²A2W Condition : (Heating) Water In/Out 47°C/55°C, Outdoor Air 7°C[DB]/6°C[WB].

³65°C down to +10°C (max. 60°C down to -5°C)

⁴Sound pressure level is obtained in an anechoic room. Sound pressure level is a relative value, depending on the distance and acoustic environment. Sound pressure level may differ depending on operation conditions.

⁵ODU : Outdoor Unit, IDU : Indoor Unit

Specifications

ClimateHub TDM Plus (R410A) (Continued)



		Indoor Unit		AE260TNWTEH/EU	AE260TNWTEH/EU	
		Outdoor Unit		AE090MXTPEH/EU	AE120MXTPEH/EU	
		Controller		MWR-WW10N	MWR-WW10N	
System	Operation	Nominal Capacity	Heating A7/W35 ¹ / A7/W55 ²	kW	9.0/ 7.7	12.0/10.7
			Cooling A35/W18 ¹	kW	8.0	12.0
	Power Input (Nominal)		Heating A7/W35 ¹ / A7/W55 ²	kW	2.12/ 2.82	2.72/ 3.91
			Cooling A35/W18 ¹	kW	1.85	2.90
		COP (Nominal Heating) A7/W35 ¹ / A7/W55 ²	W/W	4.25/ 2.72	4.41/ 2.74	
		EER (Nominal Cooling) A35/W18 ¹	W/W	4.32	4.14	
		SCOP LWT 35°C/ 55°C	W/W	4.42/ 3.01	4.65/ 2.92	
		Seasonal space heating enr. efficiency η _s LWT 35°C/ 55°C	ETA%	174/ 117	183/114	
		Average Seasonal space heating eff. class ** LWT 35°C/ 55°C	-	A++ / A+	A+++ / A+	
	Current	MCA	A	22.00	28.00	
		MFA	A	27.50	35.00	
	Maximum allowable IDU ⁵ connections (Hydro A2Wunit not included)	Max. number of IDU ⁵	EA	4	5	
		Total capacity Min. (Cooling)	kW	4.50	6.00	
	Leaving Water Temperature ³	Total capacity Min. (Cooling)	kW	9.00	12.10	
		Heating	°C	15-55	15-55	
	Functions	Cooling	°C	5-25	5-25	
		Smart Grid Ready / PV Enabled	-	•	•	
		3-Step Quiet Mode	-	•	•	
	Tank Integrated Hydro Unit	2-zone Control	-	•	•	
		Power Supply	Φ, #, V, Hz	1Φ, 2, 220-240 V, 50 Hz	1Φ, 2, 220-240 V, 50 Hz	
Water Tank Volume		litres	260	260		
Declared Load Profile		L/XL	XL	XL		
Average water heating efficiency η _{wh}		ETA%	105	95		
Average Energy Efficiency Class		-	A	A		
Heater		Back-up heater Capacity	Default (Option)	kW	2 (4/6)	2 (4/6)
Sound		Sound Pressure ⁴	Heating Std	dB(A)	29	29
			Cooling Std	dB(A)	29	29
Sound Power		Heating Std	dB(A)	43	47	
	Piping		Water pipe (Space Heating)	Inlet/Outlet	Φ, inch	1+1/4"
Dimensions	Net Weight	kg	147	147		
	Net Dimensions (WxHxD)	mm	595 x 1,800 x 700	595 x 1,800 x 700		
Outdoor Unit	Power Supply	Φ, V, Hz	1Φ, 2, 220-240 V, 50 Hz	1Φ, 2, 220-240 V, 50 Hz		
	Compressor	Type	-	Rotary Comp	Rotary Comp	
	Base Heater	Capacity	kW	-	-	
	Sound	Sound Pressure ⁴	Heating Std	dB(A)	51	52
			Cooling Std	dB(A)	50	51
			Sound Power	Heating Std	dB(A)	69
	Dimensions	Net Weight	kg	74.0	107.0	
		Net Dimensions (WxHxD)	mm	940 x 998 x 330	940 x 1,420 x 330	
	Refrigerant	Type	Type	R410A (Fluorinated greenhouse gas, GWP=2,088)	R410A (Fluorinated greenhouse gas, GWP=2,088)	
		Factory Charging	tCO ₂ e	5.01	7.31	
	Piping	Piping Connections	Liquid Pipe	Φ, mm (inch)	9.52 (3/8")	9.52 (3/8")
			Gas Pipe	Φ, mm (inch)	15.88 (5/8")	15.88 (5/8")
		Piping length (ODU-IDU) ⁵	Max.[Equiv.]	m	30	70
		Level difference (IDU-IDU) ⁵	Max.	m	20	30
		Chargeless length	m	10	10	
		Operation	Ambient Temperature A2W	Heating	°C	-25-35
	Cooling			°C	10-46	10-46
	DHW			°C	-25-43	-25-43
	Ambient Temperature A2A		Heating	°C	-25-24	-25-24
		Cooling	°C	10-46	10-46	

Accessories



Touch Controller	Touch Controller	DMS2.5	Wi-Fi Kit	External Room Sensor	Backup Heater (4/6kW)
MWR-WW10*N	MCM-A300N	MIM-D01AN	MIM-H04EN	MRW-TA	MHC-*00FE



AE260TNWTEH/EU AE160MXTPEH/EU MWR-WW10N	AE260TNWTEH/EU AE090MXTPGH/EU MWR-WW10N	AE260TNWTEH/EU AE120MXTPGH/EU MWR-WW10N	AE260TNWTEH/EU AE160MXTPGH/EU MWR-WW10N
16.0/14.6	9.0/7.7	12.0/10.7	16.0/14.6
14.5	8.0	12.0	14.5
3.95/ 5.32	2.12/ 2.82	2.72/ 3.91	3.95/ 5.32
3.84	1.86	2.90	3.84
4.05/2.74	4.25/2.69	4.41/ 2.74	4.05/2.74
3.78	4.30	4.14	3.78
4.63/3.06	4.44/2.86	4.65/2.92	4.63/ 3.06
182/119	175/111	183/114	182/119
A+++ / A+	A+++ / A+	A+++ / A+	A+++ / A+
32.00	10.00	10.00	12.00
40.00	16.10	16.10	16.10
7	4	5	7
7.70	4.50	6.00	7.70
15.40	9.00	12.10	15.40
15-55	15-55	15-55	15-55
5-25	5-25	5-25	5-25
•	•	•	•
•	•	•	•
•	•	•	•
1φ, 2, 220-240 V, 50 Hz	1φ, 2, 220-240 V, 50 Hz	1φ, 2, 220-240 V, 50 Hz	1φ, 2, 220-240 V, 50 Hz
260	260	260	260
XL	XL	XL	XL
95	105	95	95
A	A	A	A
2 (4/6)	2 (4/6)	2 (4/6)	2 (4/6)
29	29	29	29
29	29	29	29
47	43	47	47
1+1/4"	1+1/4"	1+1/4"	1+1/4"
147	147	147	147
595 x 1,800 x 700	595 x 1,800 x 700	595 x 1,800 x 700	595 x 1,800 x 700
1φ, 2, 220-240 V, 50 Hz	3φ, 4, 380-415 V, 50 Hz	3φ, 4, 380-415 V, 50 Hz	3φ, 4, 380-415 V, 50 Hz
Rotary Comp	Rotary Comp	Rotary Comp	Rotary Comp
-	-	-	-
55	51	52	55
54	50	51	54
73	69	70	73
107.0	76.0	107.0	107.0
940 x 1,420 x 330	940 x 998 x 330	940 x 1,420 x 330	940 x 1,420 x 330
R410A (Fluorinated greenhouse gas, GWP=2,088)			
7.31	5.01	7.31	7.31
3.5	2.4	3.5	3.5
9.52 (3/8")	9.52 (3/8")	9.52 (3/8")	9.52 (3/8")
15.88 (5/8")	15.88 (5/8")	15.88 (5/8")	15.88 (5/8")
70	30	70	70
30	20	30	30
10	10	10	10
-25-35	-25-35	-25-35	-25-35
10-46	10-46	10-46	10-46
-25-43	-25-43	-25-43	-25-43
-25-24	-25-24	-25-24	-25-24
10-46	10-46	10-46	10-46



³35dB(A) is only applicable for 6kW and 9kW outdoor units down to +4°C stated in 3 m distance in an anechoic environment.

^{**}A+++ energy label is available according to EU No. 811/2013 label classification 2019, on a scale from D to A+++

¹A2W Condition : (Heating) Water In/Out 30°C/35°C, Outdoor Air 7°C[DB]/6°C[WB]; (Cooling) Water In/Out 23°C/18°C, Outdoor Air 35°C[DB].

²A2W Condition : (Heating) Water In/Out 47°C/55°C, Outdoor Air 7°C[DB]/6°C[WB].

³65°C down to +10°C (max. 60°C down to -5°C)

⁴Sound pressure level is obtained in an anechoic room. Sound pressure level is a relative value, depending on the distance and acoustic environment. Sound pressure level may differ depending on operation conditions.

⁵ODU : Outdoor Unit, IDU : Indoor Unit

Specifications

TDM Plus with Third party tank connection (R410A)

- 'All in one' air-to-water and air-to-air system
- Connectable with R410A Split ODU in combination of third party Tank
- Compatible with room thermostats, solar pumps, 2- or 3-way valves and back-up boilers
- PV Enabled and Smart Grid ready.
- 2-zone Control, suitable for floor heating and radiators.
- Backup heater is recommended to ensure a minimum water temperature.



		Indoor Unit		AE090BNYDEH/EU	AE090BNYDEH/EU	AE090BNYDEH/EU	AE090BNYDEH/EU	
		Outdoor Unit		AE044MXTPEH/EU	AE066MXTPEH/EU	AE090MXTPEH/EU	AE090MXTPGH/EU	
System	Operation	Nominal Capacity	Heating A7/W35 ¹ / A7/W55 ²	kW	4.4/ 3.8	6.6/ 4.8	9.0/ 7.7	9.0/ 7.7
			Cooling A35/W18 ¹	kW	5.1	6.7	8.0	8.0
	Power Input (Nominal)		Heating A7/W35 ¹ / A7/W55 ²	kW	0.93/1.37	1.47/1.85	2.12/ 2.82	2.12/ 2.82
			Cooling A35/W18 ¹	kW	1.03	1.48	1.85	1.86
		COP (Nominal Heating) A7/W35 ¹	W/W	4.73/2.80	4.49/2.59	4.25/2.72	4.25/2.69	
		EER (Nominal Cooling) A35/W18 ¹	W/W	4.95	4.53	4.32	4.30	
		SCOP LWT 35°C/ 55°C	W/W	4.41/ 2.83	4.41/2.96	4.42/ 3.01	4.44/ 2.86	
		Seasonal space heating enr. efficiency η _s LWT 35°C/ 55°C	ETA%	173/110	173/115	174/117	175/111	
		Seasonal Space Heating Eff. Class LWT 35°C/55°C		A++ / A+	A++ / A+	A++ / A+	A+++ / A+	
	Current	MCA	A	18	20	22	10	
		MFA	A	25.0	25.0	27.5	16.1	
	Maximum Allowable IDU ⁶ Connections (Hydro A2W Unit Not included)		Max. Number of IDU ⁶	EA	2	3	4	4
			Total Capacity Min. (Cooling)	kW	2.2	3.3	4.5	4.5
			Total Capacity Min. (Cooling)	kW	4.4	6.6	9.0	9.0
	Leaving Water Temperature ³	Heating	°C	15-55 (H/P: 25-55)	15-55 (H/P: 25-55)	15-55 (H/P: 25-55)	15-55 (H/P: 25-55)	
Cooling		°C	5-25	5-25	5-25	5-25		
Functions	Smart Grid Ready/PV Enabled	-	•	•	•	•		
	3-Step Quiet Mode	-	•	•	•	•		
	2-zone Control	-	•	•	•	•		
Wall-Mounted Hydro Unit	Power Supply		Φ, #, V, Hz	1Φ, 2, 220-240 V, 50 Hz	1Φ, 2, 220-240 V, 50 Hz	1Φ, 2, 220-240 V, 50 Hz	3Φ, 4, 380-415 V, 50 Hz	
	Expansion Vessel		litres	8	8	8	8	
	Heater	Back-up heater Capacity	kW	4	4	4	6	
	Sound	Sound Pressure ⁴	Std	dB(A)	31	31	31	31
		Sound Power	Std	dB(A)	48	48	48	48
	Piping	Water pipe	Inlet/Outlet	Φ, inch	1+1/4"	1+1/4"	1+1/4"	1+1/4"
	Dimensions	Net Weight		kg	45.5	45.5	45.5	46.5
Net Dimensions (WxHxD)			mm	510 x 850 x 315	510 x 850 x 315	510 x 850 x 315	510 x 850 x 315	
Outdoor Unit	Power Supply		Φ, V, Hz	1Φ, 2, 220-240 V, 50 Hz	1Φ, 2, 220-240 V, 50 Hz	1Φ, 2, 220-240 V, 50 Hz	3Φ, 4, 380-415 V, 50 Hz	
	Compressor	Type	-	Rotary Comp	Rotary Comp	Rotary Comp	Rotary Comp	
	Base Heater	Capacity	kW	-	-	-	-	
	Sound	Sound Pressure ⁴	Heating Std	dB(A)	47	48	51	51
			Cooling Std	dB(A)	46	47	50	50
		Sound Power	Heating Std	dB(A)	65	67	69	69
	Dimensions	Net Weight		kg	61	61	74	76
		Net Dimensions (WxHxD)		mm	880 x 793 x 310	880 x 793 x 310	940 x 998 x 330	940 x 998 x 330
	Refrigerant	Type		-	R410A (Fluorinated greenhouse gas, GWP=2,088)			
		Factory Charging		tCO ₂ e	5.43	5.43	5.01	5.01
				kg	2.6	2.6	2.4	2.4
	Piping	Piping Connections	Liquid Pipe	Φ, mm (inch)	9.52 (3/8")	9.52 (3/8")	9.52 (3/8")	9.52 (3/8")
			Gas Pipe	Φ, mm (inch)	15.88 (5/8")	15.88 (5/8")	15.88 (5/8")	15.88 (5/8")
		Piping Length (ODU-IDU) ⁵	Max. [Equiv.]	m	30	30	30	30
		Level Difference (IDU-IDU) ⁵	Max.	m	20	20	20	20
Chargeless Length			m	10	10	10	10	
Operation	Ambient Temperature A2W	Heating	°C	-25-35	-25-35	-25-35	-25-35	
		Cooling	°C	10-46	10-46	10-46	10-46	
		DHW	°C	-25-43	-25-43	-25-43	-25-43	
	Ambient Temperature A2A	Heating	°C	-25-24	-25-24	-25-24	-25-24	
		Cooling	°C	10-46	10-46	10-46	10-46	

Accessories



EHS Controller (included)	Touch Controller	DMS2.5	Wi-Fi Kit	External Room Sensor
MWR-WW10*N	MCM-A300N	MIM-D01AN	MIM-H04EN	MRW-TA



AE160BNYDEH/EU AE120MXTPEH/EU	AE160BNYDGH/EU AE120MXTPGH/EU	AE160BNYDEH/EU AE160MXTPEH/EU	AE160BNYDGH/EU AE160MXTPGH/EU
12.0/10.7	12.0/10.7	16.0/14.6	16.0/14.6
12.0	12.0	14.5	14.5
2.72/ 3.91	2.72/ 3.91	3.95/ 5.32	3.95/ 5.32
2.90	2.90	3.84	3.84
4.41/2.74	4.41/2.74	4.05/2.74	4.05/2.74
4.14	4.14	3.78	3.78
4.65/ 2.92	4.65/ 2.92	4.63/ 3.06	4.63/ 3.06
183/114	183/114	182/119	182/119
28	10	32	12
35.0	16.1	40.0	16.1
5	5	7	7
6.0	6.0	7.7	7.7
12.1	12.1	15.4	15.4
15-55 (H/P : 25-55)	15-55 (H/P : 25-55)	15-55 (H/P : 25-55)	15-55 (H/P : 25-55)
5-25	5-25	5-25	5-25
•	•	•	•
•	•	•	•
•	•	•	•
1Φ, 2, 220-240 V, 50 Hz	3Φ, 4, 380-415 V, 50 Hz	1Φ, 2, 220-240 V, 50 Hz	3Φ, 4, 380-415 V, 50 Hz
8	8	8	8
6	6	6	6
38	38	38	38
55	55	55	55
1+1/4"	1+1/4"	1+1/4"	1+1/4"
46.5	46.5	46.5	46.5
510 x 850 x 315	510 x 850 x 315	510 x 850 x 315	510 x 850 x 315
1Φ, 2, 220-240 V, 50 Hz	3Φ, 4, 380-415 V, 50 Hz	1Φ, 2, 220-240 V, 50 Hz	3Φ, 4, 380-415 V, 50 Hz
Rotary Comp	Rotary Comp	Rotary Comp	Rotary Comp
-	-	-	-
52	52	55	55
51	51	54	54
70	70	73	73
107	107	107	107
940 x 1,420 x 330	940 x 1,420 x 330	940 x 1,420 x 330	940 x 1,420 x 330
R410A (Fluorinated greenhouse gas, GWP=2,088)			
7.31	7.31	7.31	7.31
3.5	3.5	3.5	3.5
9.52 (3/8")	9.52 (3/8")	9.52 (3/8")	9.52 (3/8")
15.88 (5/8")	15.88 (5/8")	15.88 (5/8")	15.88 (5/8")
70	70	70	70
30	30	30	30
10	10	10	10
-25-35	-25-35	-25-35	-25-35
10-46	10-46	10-46	10-46
-25-43	-25-43	-25-43	-25-43
-25-24	-25-24	-25-24	-25-24
10-46	10-46	10-46	10-46



³35dB(A) is only applicable for 6kW and 9kW outdoor units down to +4°C stated in 3 m distance in an anechoic environment.

^{**}A+++ energy label is available according to EU No. 811/2013 label classification 2019, on a scale from D to A+++

¹A2W Condition: (Heating) Water In/Out 30°C/35°C, Outdoor Air 7°C[DB]/6°C[WB]; (Cooling) Water In/Out 23°C/18°C, Outdoor Air 35°C[DB].

²A2W Condition: (Heating) Water In/Out 47°C/55°C, Outdoor Air 7°C[DB]/6°C[WB].

³65°C down to +10°C (max. 60°C down to -5°C)

⁴Sound pressure level is obtained in an anechoic room. Sound pressure level is a relative value, depending on the distance and acoustic environment. Sound pressure level may differ depending on operation conditions.

⁵ODU: Outdoor Unit, IDU: Indoor Unit

Specifications

TDM Plus WindFree™ Deluxe

- Three-step cooling: Fast Cooling mode.
- WindFree™ Cooling Mode.
- Wi-Fi Control with SmartThings and Bixby voice controls.
- Equipped with NASA communication protocol.
- Equipped with Easy Filter Plus.



Type			TDM Plus WindFree™ Deluxe	TDM Plus WindFree™ Deluxe	TDM Plus WindFree™ Deluxe
Model Name			AE022TNXDEH/EU	AE028TNXDEH/EU	AE036TNXDEH/EU
Power Supply		Φ, #, V, Hz	1Φ, 2, 220~240 V, 50 Hz	1Φ, 2, 220~240 V, 50 Hz	1Φ, 2, 220~240 V, 50 Hz
Capacity	Cooling	kW	2.20	2.80	3.60
	Heating	kW	2.50	3.20	4.00
Power Input (Nominal)	Cooling	W	24.0	30.0	37.0
	Heating	W	24.0	30.0	37.0
Current Input (Nominal)	Cooling	A	0.16	0.20	0.25
	Heating	A	0.16	0.20	0.25
Fan	Type	-	Cross flow Fan	Cross flow Fan	Cross flow Fan
	Quantity	EA	1	1	1
	Air Flow Rate H/M/L	m³/min	5.7/5.0/4.5	8.5/7.7/6.9	10.3/9.1/8.3
		l/s	95.0/83.3/75.0	141.7/128.3/115.0	171.7/151.7/138.3
Fan motor	Type	-	BLDC	BLDC	BLDC
	Output xn	W	27x1	27x1	27x1
Piping Connections	Liquid Pipe	Φ, mm(inch)	6.35 (1/4")	6.35 (1/4")	6.35 (1/4")
	Gas Pipe	Φ, mm(inch)	12.7 (1/2")	12.7 (1/2")	12.7 (1/2")
Wiring connections	For power supply below 20m/over 20m (min)	mm²	1.5/2.5	1.5/2.5	1.5/2.5
	Communication (min)	mm²	0.75	0.75	0.75
Refrigerant	Type	-	R410A (Fluorinated greenhouse gas, GWP=2,088)		
	Control Method ¹	-	EEV NOT INCLUDED	EEV NOT INCLUDED	EEV NOT INCLUDED
Sound	Sound Pressure H/M/L/WF ²	dB(A)	34/32/30/27	34/33/32/26	40/36/34/26
	Sound Power	dB(A)	51	52	56
Dimensions	Net Weight	kg	8.50	9.00	9.00
	Net Dimensions (WxHxD)	mm	820 x 299 x 215	820 x 299 x 215	820 x 299 x 215
Functions					
Air Flow	WindFree™ Cooling		•	•	•
	Air Direction Control (Up/Down)		Auto	Auto	Auto
	Air Direction Control (Left/Right)		Auto	Auto	Auto
Air Purification	Auto Fan speed		•	•	•
	Tri-Care Filter		-	-	-
	Easy Filter Plus		•	•	•
	Auto Clean (Self Cleaning)		•	•	•
Operating Mode	2 Step Cooling		•	•	•
	AI Auto Comfort with Wi-Fi & MDS (direct/indirect)		-	-	-
	AI Auto Comfort with Wi-Fi		-	-	-
	Auto Mode (without Wi-Fi)		-	-	-
	Fast Cooling		•	•	•
	Good Sleep		•	•	•
	Eco		•	•	•
	Dehumidification		•	•	•
	Fan		•	•	•
	Quiet		•	•	•
Other Functions	Samsung SmartThings		•	•	•
	MDS (Motion Detect Sensor)		-	-	-
	Indoor Temp. Display		•	•	•
	Display On/Off	88 Display	•	•	•
	Beep On/Off		•	•	•
	Auto Changeover		•	•	•
	Auto Restart		•	•	•

Specifications

TDM Plus Slim Duct

- Slim design with thickness of just 199 mm.
- Antibacterial filter included.



Type			Slim Duct	Slim Duct	Slim Duct	Slim Duct	
Model Name			AE022ANLDEH/EU	AE028ANLDEH/EU	AE036ANLDEH/EU	AE056ANLDEH/EU	
Power Supply		Φ, #, V, Hz	1Φ, 2, 220-240 V, 50 Hz	1Φ, 2, 220-240 V, 50 Hz	1Φ, 2, 220-240 V, 50 Hz	1Φ, 2, 220-240 V, 50 Hz	
Performance	Capacity	Cooling/Heating	kW	2.2/2.5	2.8/3.2	3.6/4.0	5.6/6.3
	Power Input	Cooling/Heating	W	30/30	34/36	40/42	73/68
Power	Current Input	Cooling/Heating	A	0.25/0.25	0.28/0.30	0.33/0.35	0.62/0.58
	Type		-	Sirocco Fan	Sirocco Fan	Sirocco Fan	Sirocco Fan
Fan	Quantity		EA	2	2	2	2
	Air Flow Rate	H/M/L (UL)	m ³ /min	6/4.9/3.8	7.05/5.15/4.35	8.20/6.50/4.9	15.5/12.5/9.5
	External Pressure	Max. (Min/Std/Max)	mmAq	0/1/3	0/1/3	0/1/3	0/2/4
Pa			0/9.8/29.4	0/9.8/29.4	0/9.8/29.4	0/19.6/39.2	
Fan Motor	Type		-	SSR non-feedback	SSR non-feedback	SSR non-feedback	SSR non-feedback
	Output		W	69	69	69	69
Piping Connections	Liquid Pipe		Φ, mm (inch)	6.35 (1/4")	6.35 (1/4")	6.35 (1/4")	6.35 (1/4")
	Gas Pipe		Φ, mm (inch)	12.7 (1/2")	12.7 (1/2")	12.7 (1/2")	12.7 (1/2")
Refrigerant	Type		-	R410A (Fluorinated greenhouse gas, GWP=2,088)			
Sound	Sound Pressure	H/M/L	dB(A)	26/24/21	27/25/23	29/26/23	34/30/26
	Sound Power		dB(A)	48	49	51	54
Dimensions	Net Weight		kg	15	15	17	18.9
	Net Dimensions (W×H×D)		mm	700 x 199 x 440	700 x 199 x 440	700 x 199 x 440	700 x 199 x 440
Optional Accessories	Drain Pump	Model	-	(Built-in)	(Built-in)	(Built-in)	(Built-in)
		Max. lifting Height/Displacement	mm / Litre/h	750/24	750/24	750/24	750/24

Accessories



Drain Pump (Built-in)

Remote Control

Touch Controller

Wireless Receiver Kit

Touch Controller

DMS2.5

MDP-E075SEE3D

AR-EH00

MWR-SH11N

MRK-A10N

MCM-A300N

MIM-D01AN



Wi-Fi Kit

External Room Sensor

Y-joint

MIM-H04EN

MRW-TA

MXJ-YA1509M

Specifications

TDM Plus MSP Duct

- External static pressure range from 0 to 1.4 mmAq.
- Built-in electronic expansion valve (EEV) for refrigerant flow control (2000 step).
- Long-life washable permanent filter is included.
- Auto Restart function.
- Built-in condensation drain pump (750 mmH₂O).



Type			MSP Duct	MSP Duct	MSP Duct	MSP Duct	
Model Name			AE036BNMPEH/EU	AE056BNMPEH/EU	AE071MNMPEH/EU	AE090MNMPEH/EU	
Power Supply		Φ, #, V, Hz	1Φ, 2, 220-240 V, 50 Hz	1Φ, 2, 220-240 V, 50 Hz	1Φ, 2, 220-240 V, 50 Hz	1Φ, 2, 220-240 V, 50 Hz	
Performance	Capacity	Cooling / Heating	kW	3.6/4	5.6/6.3	7.1/8.0	9.0/10.0
	Power Input	Cooling / Heating	W	0.045/0.045	0.07/0.07	120/120	145/145
Power	Current Input	Cooling / Heating	A	0.4/0.4	0.6/0.6	1.0/1.0	1.2/1.2
	Type		-	Sirocco Fan	Sirocco Fan	Sirocco Fan	Sirocco Fan
Fan	Quantity		EA	2	2	2	2
	Air Flow Rate	H/M/L (UL)	m ³ /min	12.0/9.5/7.5	16.0/13.5/9.0	22/19/16	29/25/22
	External Pressure	Max. (Min/Std/Max)	mmAq	0/2.5/15	0/3/15	0/3/15	0/4/15
Pa			0/24.5/147.0	0/29.4/147.0	0/29.4/147.2	0/29.4/147.2	
Fan Motor	Type		-	BLDC Feedback	BLDC Feedback	BLDC Feedback	BLDC Feedback
	Output x n		W	153x1	153x1	153x1	153x1
Piping Connections	Liquid Pipe		Φ, mm (inch)	6.35 (1/4")	6.35 (1/4")	9.52 (3/8")	9.52 (3/8")
	Gas Pipe		Φ, mm (inch)	12.7 (1/2")	12.7 (1/2")	15.88 (5/8")	15.88 (5/8")
Refrigerant	Type		-	R410A (Fluorinated greenhouse gas, GWP=2,088)			
Sound	Sound Pressure	H/M/L	dB(A)	30/27/24	32/29/ 25	37/33/29	38/35/32
	Sound Power		dB(A)	53	57	57	58
Dimensions	Net Weight		kg	27.9	27.9	25.5	33
	Net Dimensions (W×H×D)		mm	32	32	850x250x700	1,200x250x700
Optional Accessories	Drain Pump	Model		MDP-G075SQ (Built-in)	MDP-G075SQ (Built-in)	MDP-G075SQ (Built-in)	MDP-G075SQ (Built-in)
				MDP-G075SP (External)	MDP-G075SP (External)	MDP-G075SP (External)	MDP-G075SP (External)
		Max. lifting Height/ Displacement		mm / Litre/h	750/24	750/24	750/24

Accessories

Drain Pump (Built-in)	External Drain Pump	Remote Control	Touch Controller	Touch Controller
MDP-G075SQ	MDP-G075SP	AR-EH00	MWR-SH11N	MCM-A300N
DMS2.5	Wi-Fi Kit	External Room Sensor	Wireless Receiver Kit	Y-joint
MIM-D01AN	MIM-H04EN	MRW-TA	MRK-A10N	MXJ-YA1509M

Specifications

TDM Plus Console

- SPI Ioniser device (included).
- Slim design with 199mm in depth.
- Built-in electronic expansion valve (EEV) for refrigerant flow control (2,000 step).
- Long-life washable permanent filter.
- Auto Restart function.
- Two separate air outlets, upper (cooling) and bottom (heating) to avoid stratifications.



Type		Console		Console		Console		Console	
Model Name		AE022MNJDEH/EU		AE028MNJDEH/ EU		AE036MNJDEH/ EU		AE056MNJDEH/ EU	
Power Supply		Φ, #, V, Hz		1Φ, 2, 220-240 V, 50 Hz		1Φ, 2, 220-240 V, 50 Hz		1Φ, 2, 220-240 V, 50 Hz	
Performance	Capacity	Cooling / Heating	kW	2.2/2.5		2.8/3.2		3.6/4.0	
	Power Input	Cooling / Heating	W	16/16		30/30		35/35	
Power	Current Input	Cooling / Heating	A	0.13/0.13		0.25/0.25		0.29/0.29	
	Type	-		Turbo Fan		Turbo Fan		Turbo Fan	
Fan	Quantity	EA		1		1		1	
	Air Flow Rate	H/M/L (UL)	m ³ /min	6.3 / 5.4 / 4.9		7.0 / 6.0 / 5.0		8.50 / 7.50 / 6.50	
Piping Connections	Liquid Pipe	Φ, mm (inch)		6.35 (1/4")		6.35 (1/4")		6.35 (1/4")	
	Gas Pipe	Φ, mm (inch)		12.7 (1/2")		12.7 (1/2")		12.7 (1/2")	
Refrigerant	Type	-		R410A (Fluorinated greenhouse gas, GWP=2,088)					
Sound	Sound Pressure	H/M/L	dB(A)	34 / 32 / 30		38 / 36 / 34		39 / 37 / 34	
	Sound Power	dB(A)		52		58		59	
Dimensions	Net Weight	kg		15,5		16		16	
	Net Dimensions (W×H×D)	mm		720 x 620 x 199		720 x 620 x 199		720 x 620 x 199	

Accessories



Touch Controller	Remote Control (Included)	Touch Controller	DMS2.5	Wi-Fi Kit	External Room Sensor	Y-joint
MWR-SH11N	MR-EH00	MCM-A300N	MIM-D01AN	MIM-H04EN	MRW-TA	MXJ-YA1509M



Dimensional Drawings

TDM Plus Tank Integrated Hydro Unit

AE200TNWTEH/EU, AE260TNWTEH/EU

Units: mm

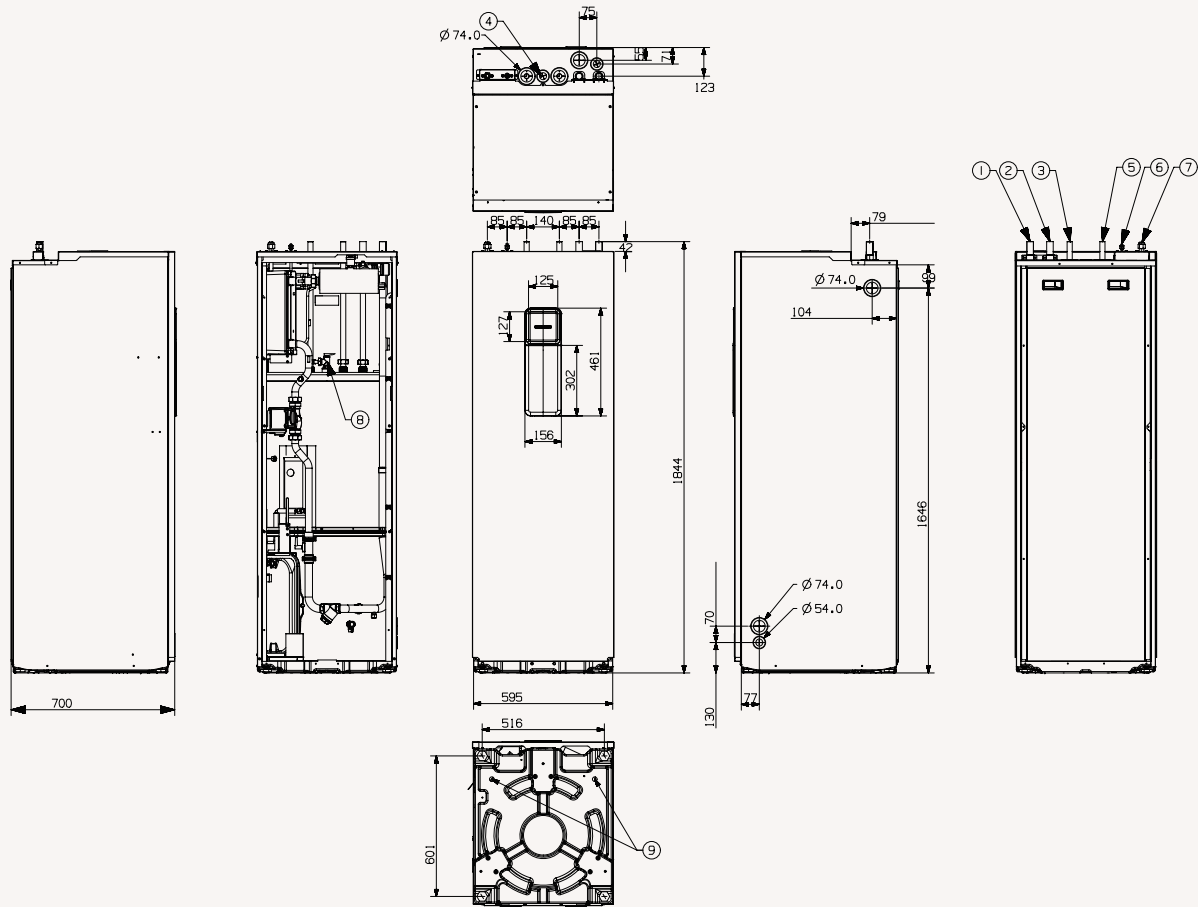

NO	Name	Description	
		AE200TNWTEH/EU	AE260TNWTEH/EU
1	Space heating Inlet	Ø28	Ø28
2	Space heating Outlet	Ø28	Ø28
3	DHW Inlet	Ø22	Ø22
4	Secondary water return	N/A	Ø22
5	DHW Outlet	Ø22	Ø22
6	Refrigerant liquid pipe	Ø6.35	Ø6.35
7	Refrigerant Gas pipe	Ø15.88	Ø15.88
8	T/Pv/v	Female PT1/2"	Female PT1/2"
9	Drain Holes	(Option) Connect with the provided drain plug	

TDM Plus Outdoor

AE044/066MXTPEH/EU

Units: mm

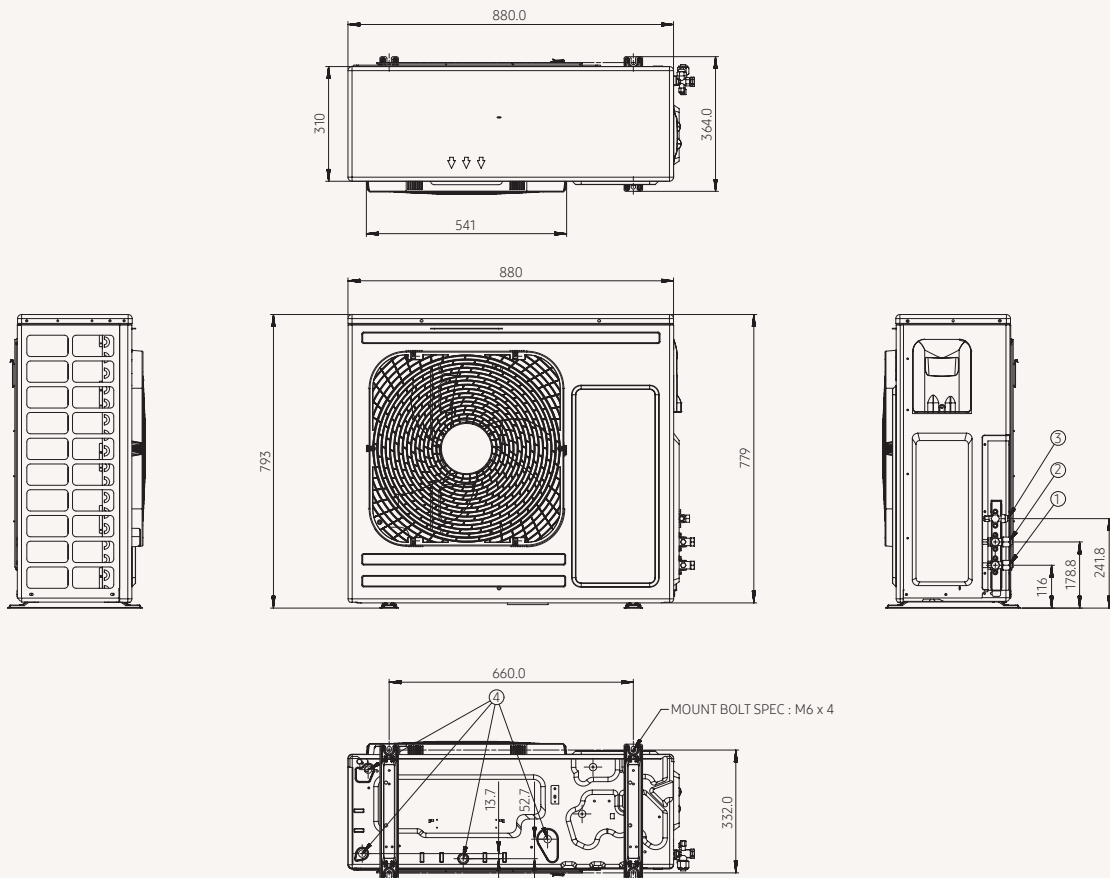

NO	Name	Description
		4.4 kW 6.6 kW
1	Refrigerant gas pipe for air	Ø15.88("5/8)
2	Refrigerant gas pipe for water	Ø15.88("5/8)
3	Refrigerant liquid pipe	Ø9.52("3/8)
4	Drain holes	Connect with the provided drain plug.

Dimensional Drawings

TDM Plus Outdoor

AE090MXTP*H/EU

Units: mm

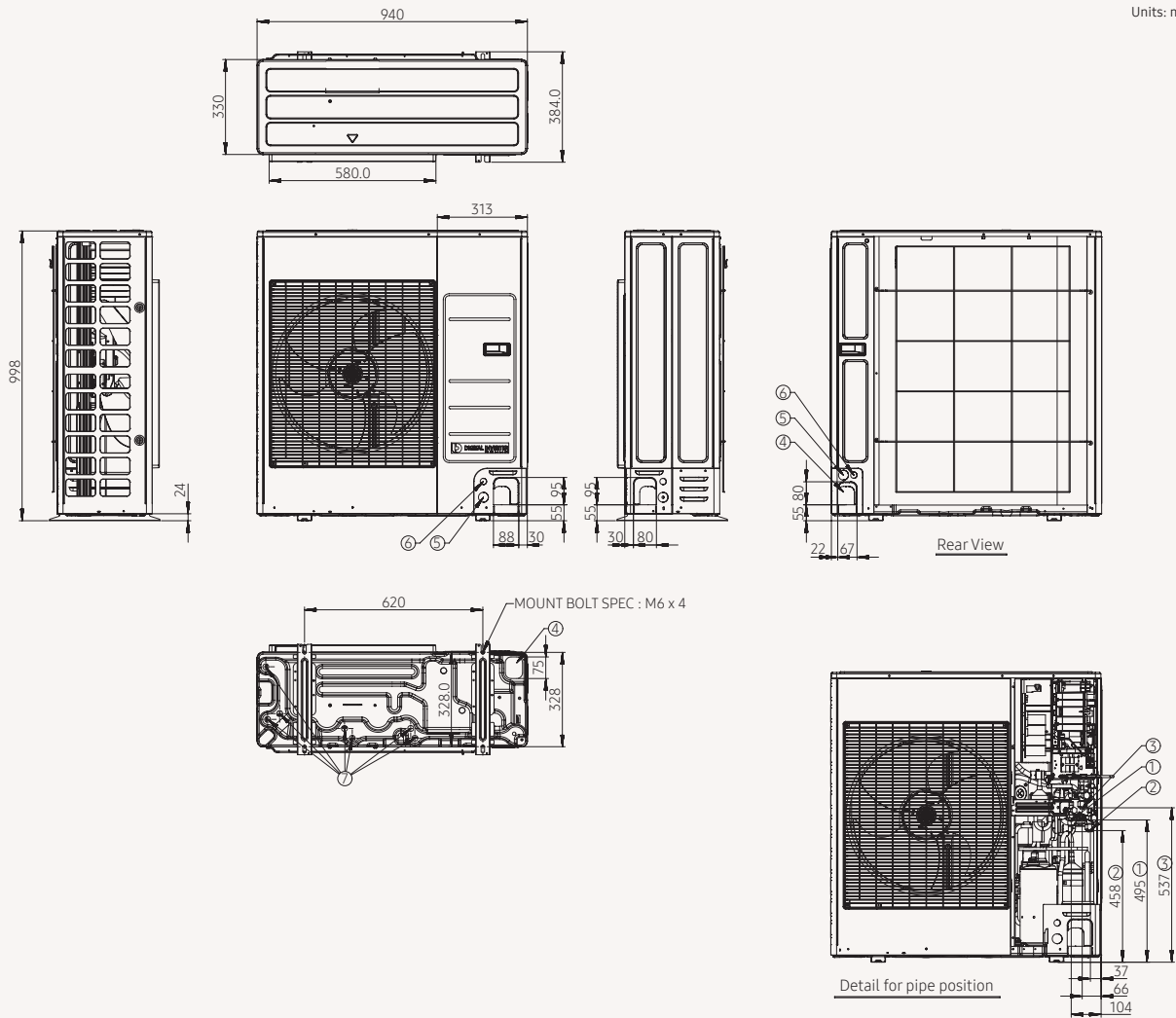

NO	Name	Description
		9 kW
1	Refrigerant liquid pipe	Φ9.52("3/8)
2	Refrigerant gas pipe for air	Φ15.88("5/8)
3	Refrigerant gas pipe for water	Φ15.88("5/8)
4	Knockout hole for pipe intake	Front / Side / Rear / Bottom
5	Power wiring conduits	Front / Side / Rear, Φ34("1-3/8)
6	Communication wiring conduits	Front / Side / Rear, Φ22("7/8)
7	Drain holes	Connect with the provided drain plug.

TDM Plus Outdoor

AE120/160MXP*H/EU

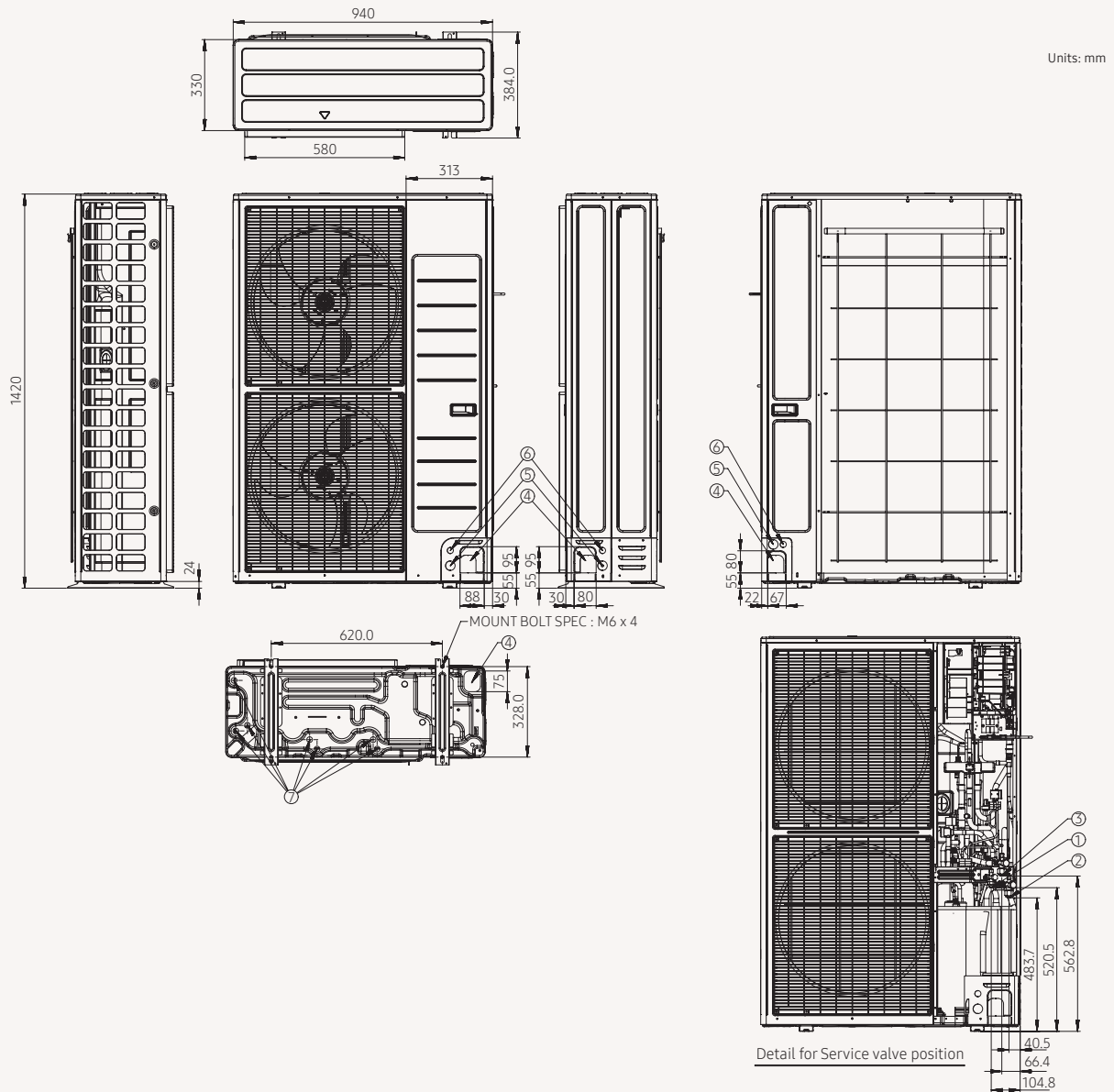

NO	Name	Description	
		12 kW	16 kW
1	Refrigerant liquid pipe	Φ9.52("3/8)	
2	Refrigerant gas pipe for air	Φ15.88("5/8)	Φ15.88("5/8)
3	Refrigerant gas pipe for water	Φ15.88("5/8)	Φ15.88("5/8)
4	Knockout hole for pipe intake	Front / Side / Rear / Bottom	Front / Side / Rear / Bottom
5	Power wiring conduits	Front / Side / Rear, Φ34("1-3/8)	Front / Side / Rear, Φ34("1-3/8)
6	Communication wiring conduits	Front / Side / Rear, Φ22("7/8)	Front / Side / Rear, Φ22("7/8)
7	Drain holes	Connect with the provided drain plug.	Connect with the provided drain plug.

WindFree™ Deluxe

AE056/071TNXDEH/EU

Units: mm

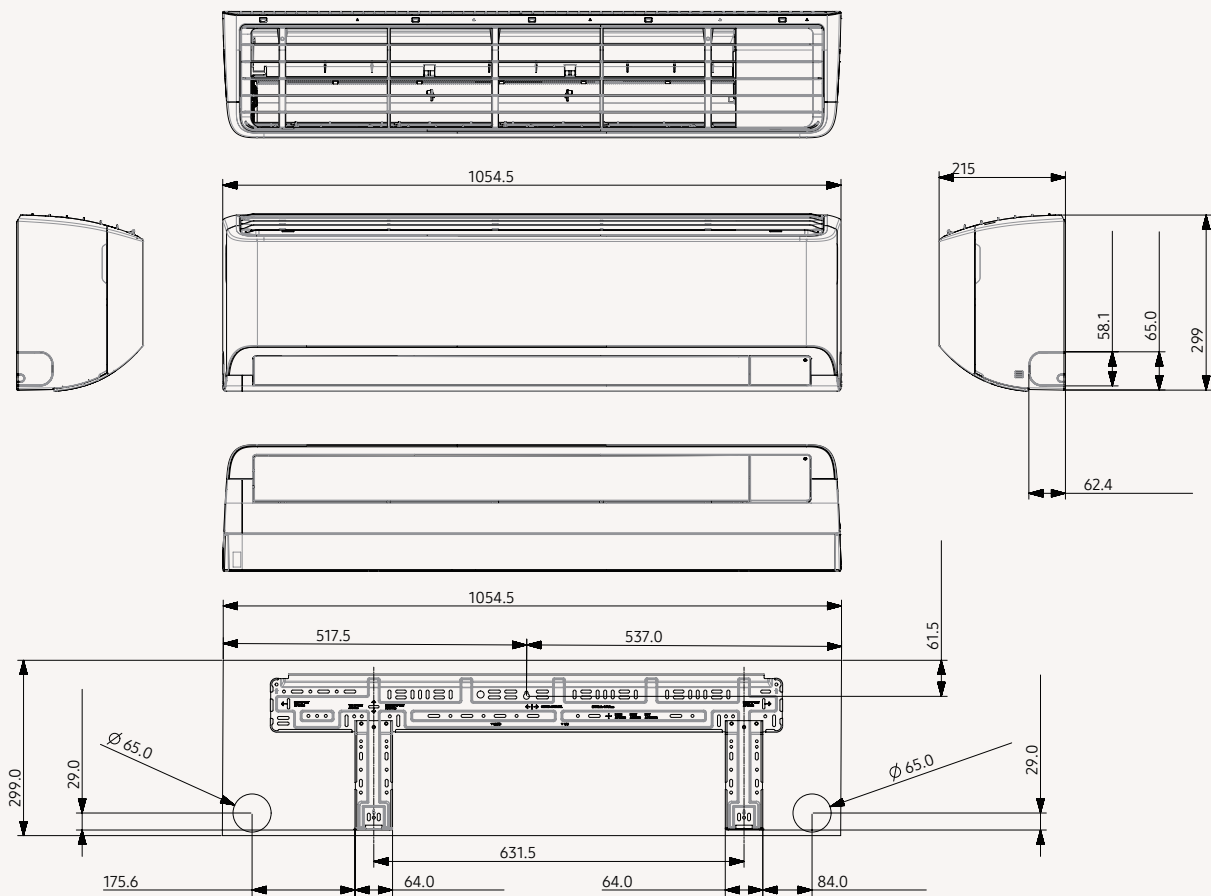

Dimensional Drawings

TDM Plus Slim Duct

AE022/028/036ANLDEH/EU

Unit: mm

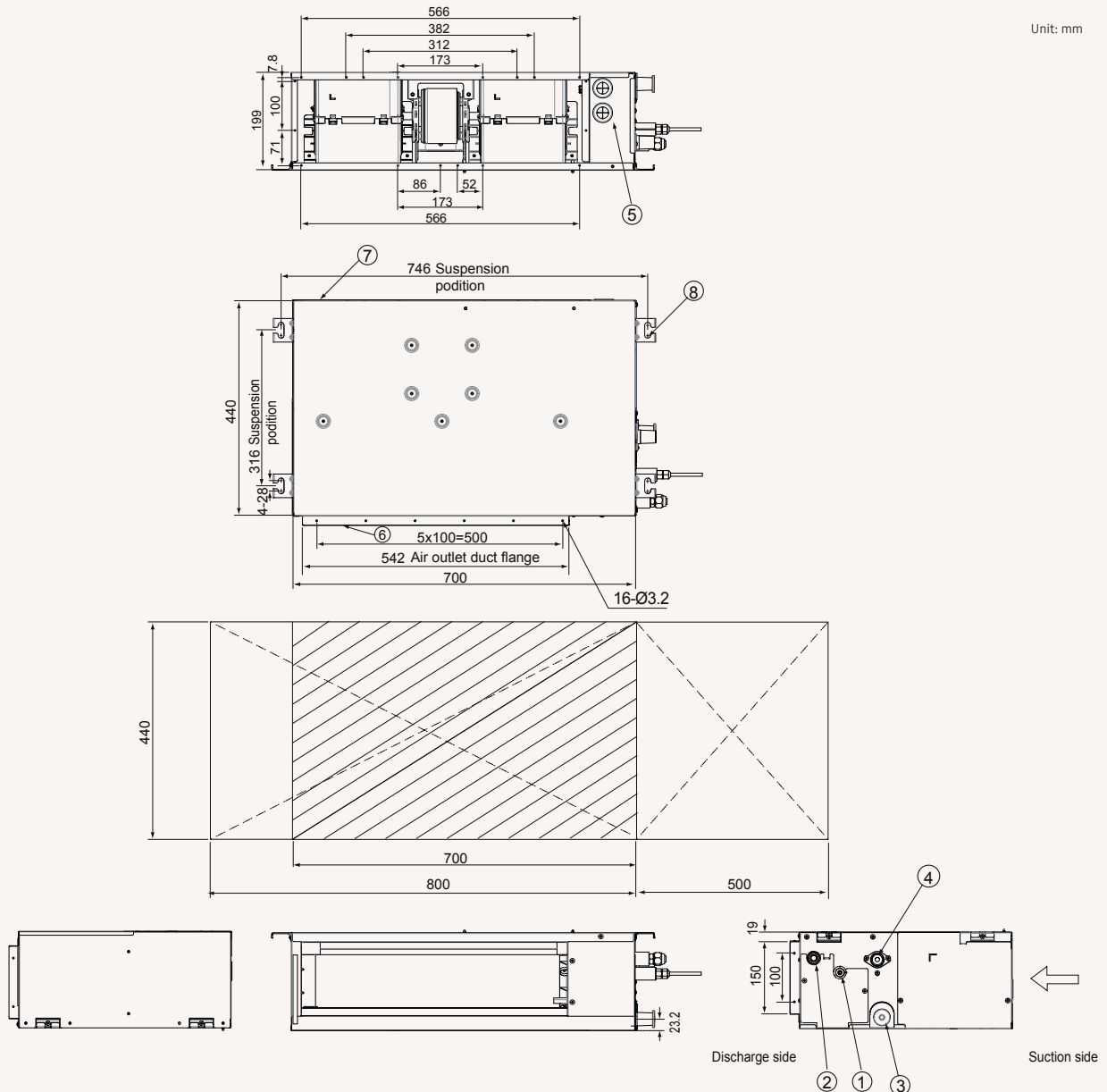

NO	Name	Description
1	Liquid pipe connection	Φ6.35(1/4")
2	Gas pipe connection	Φ12.70(1/2")
3	Drain pipe connection without drain pump	VP25(OD Φ32, ID Φ25)
4	Drain pipe connection with drain pump	VP25(OD Φ32, ID Φ25)
5	Power supply/Communication connection	-
6	Air discharge grille flange	-
7	Return air side	-
8	Hook	Φ9.52 or M10

TDM Plus Slim Duct

AE056ANLDEH/EU

Unit: mm

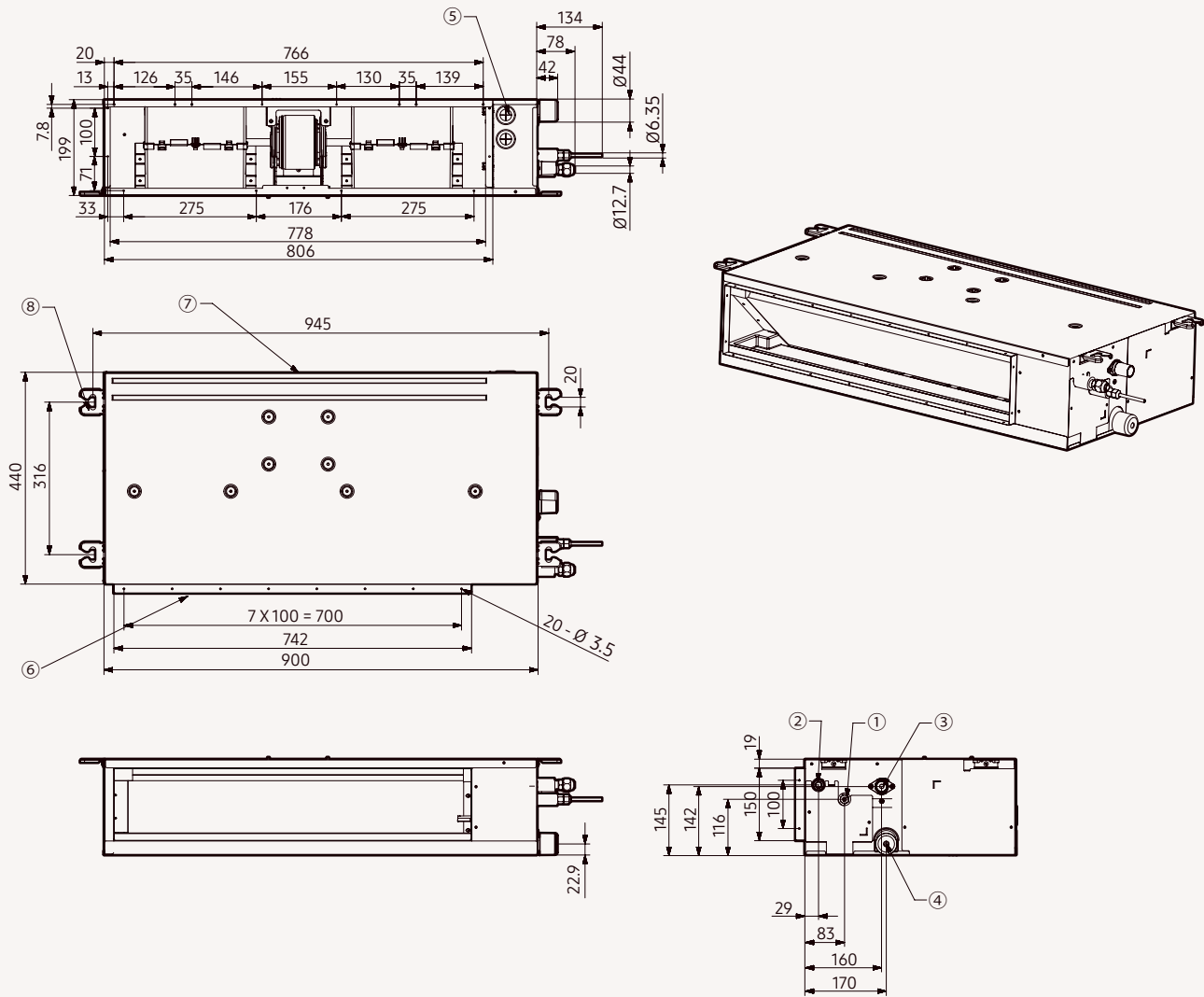

NO	Name	Description
1	Refrigerant liquid pipe	Ø6.35(1/4") Flare Connection
2	Refrigerant gas pipe	Ø12.70(1/2") Flare Connection
3	Condensate Drain	VP25(OD Ø32, ID Ø25)
4	Condensate Drain (Option)	VP25(OD Ø32, ID Ø25)
5	Power & Comm. Wiring Conduits	-
6	Supply Air Flange	-
7	Return Air Flange	-
8	Hook	-

Dimensional Drawings

TDM Plus MSP Duct

AE036/056BNMPEH/EU

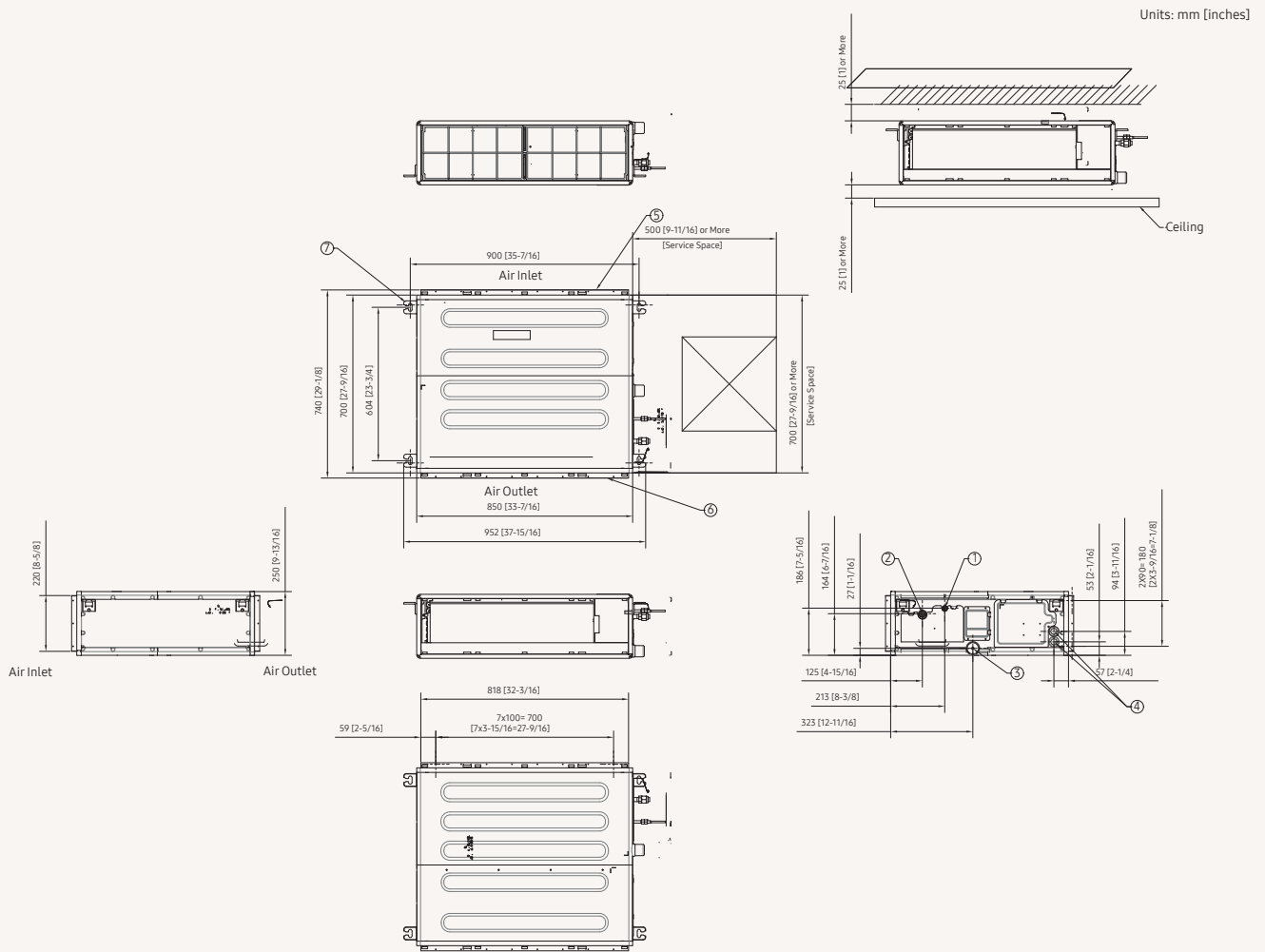

NO	Name	Description
1	Liquid pipe connection	
2	Gas pipe connection	
3	Drain hose	VP25 (OD 32, ID 25)
4	Power & communication conduits	
5	Air inlet	
6	Air outlet	
7	Hook	Use M8-M10 bolt (4ea)



Dimensional Drawings

TDM Plus MSP Duct

AE071MNMPEH/EU

Units: mm

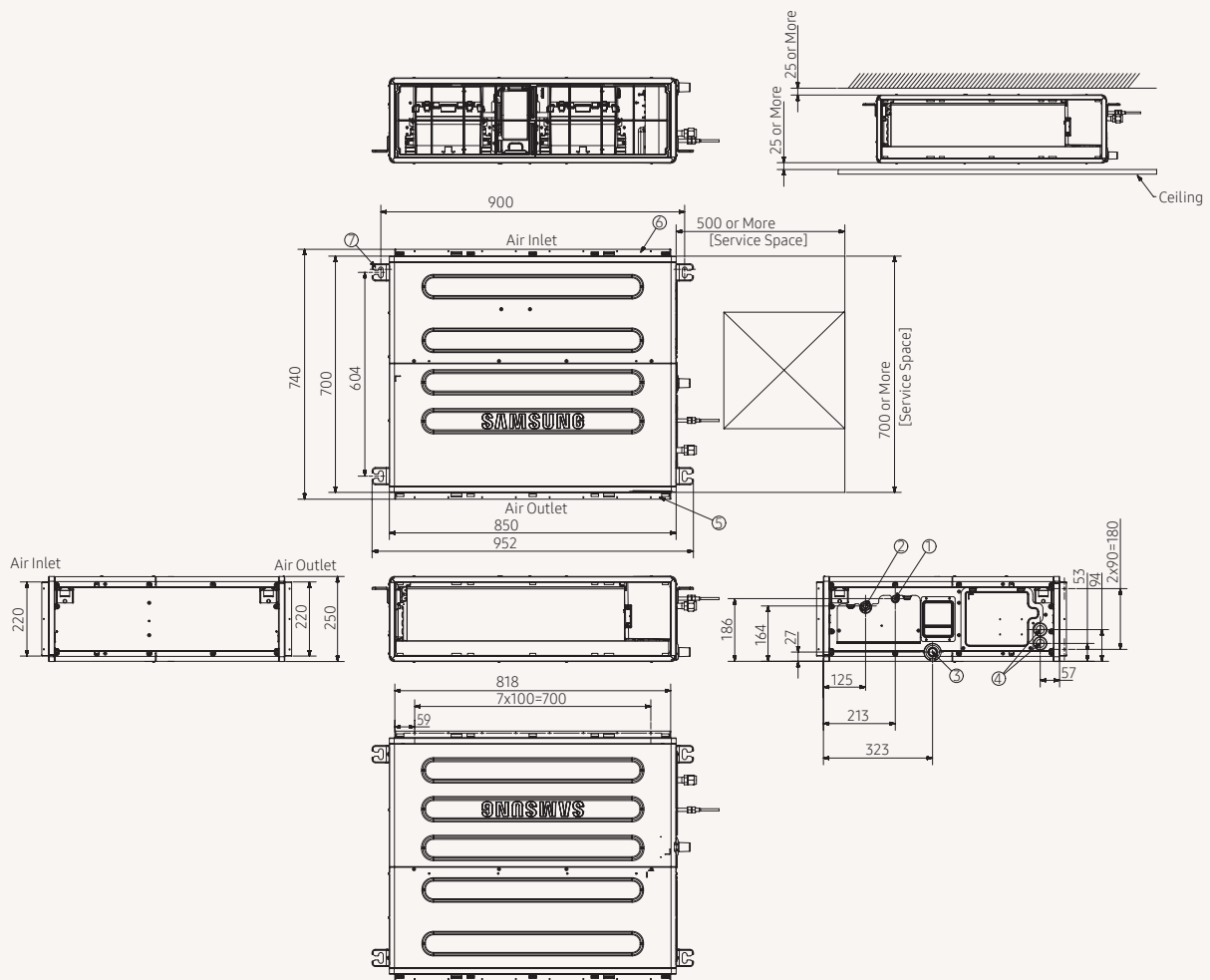

NO	Name	Description
1	Liquid pipe connection	Φ9.52 (3/8)
2	Gas pipe connection	Φ15.88 (5/8)
3	Drain pipe connection	VP-25(OD 32, ID 25)
4	Power supply & Communication wiring conduit	-
5	Air suction flange	-
6	Air discharge flange	-
7	Hook	Use M8-M10 bolt (4ea)

TDM Plus MSP Duct

AE090MNMPEH/EU

Units: mm

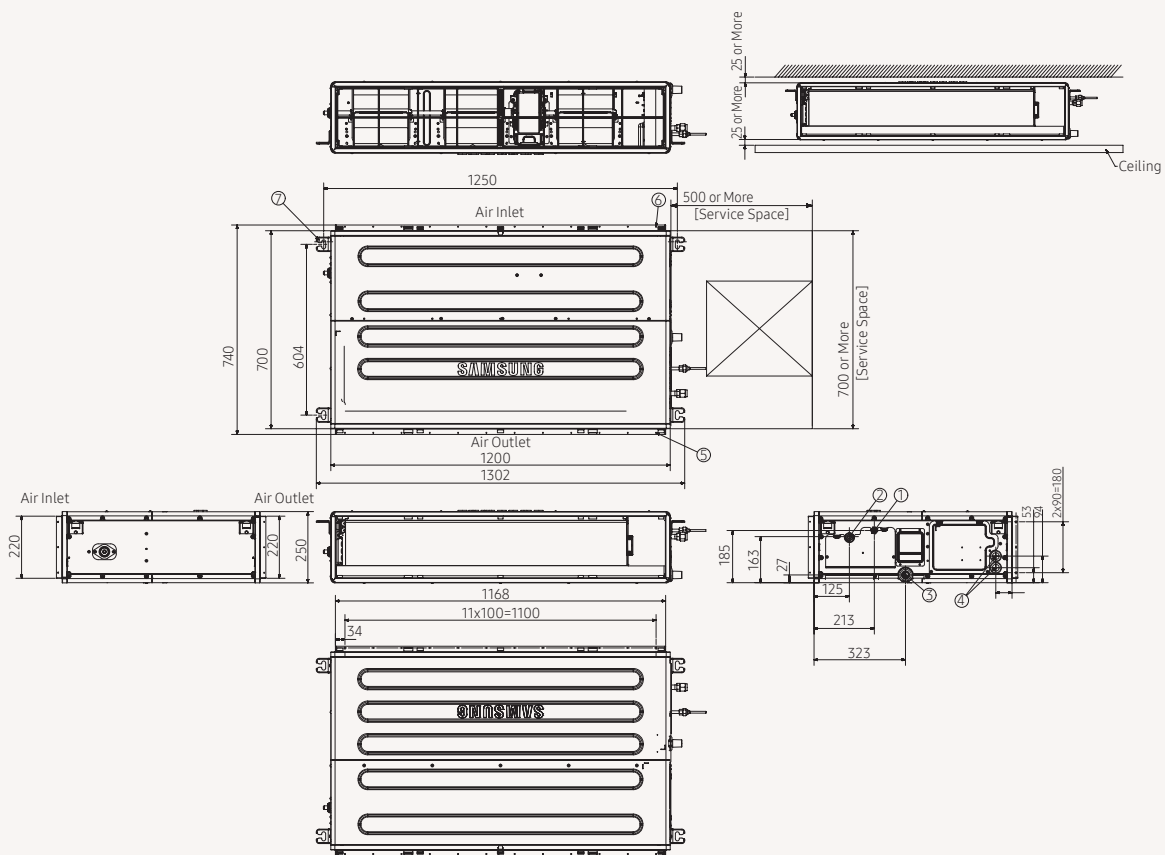

NO	Name	Description
1	Liquid pipe connection	Φ9.52 (3/8)
2	Gas pipe connection	Φ15.88 (5/8)
3	Drain pipe connection	VP-25 (OD 32, ID 25)
4	Power supply & Communication wiring conduit	-
5	Air suction flange	-
6	Air discharge flange	-
7	Hook	Use M8-M10 bolt (4ea)

Dimensional Drawings

TDM Plus Console

AE022/028/036/056MNJDEH/EU

Units: mm

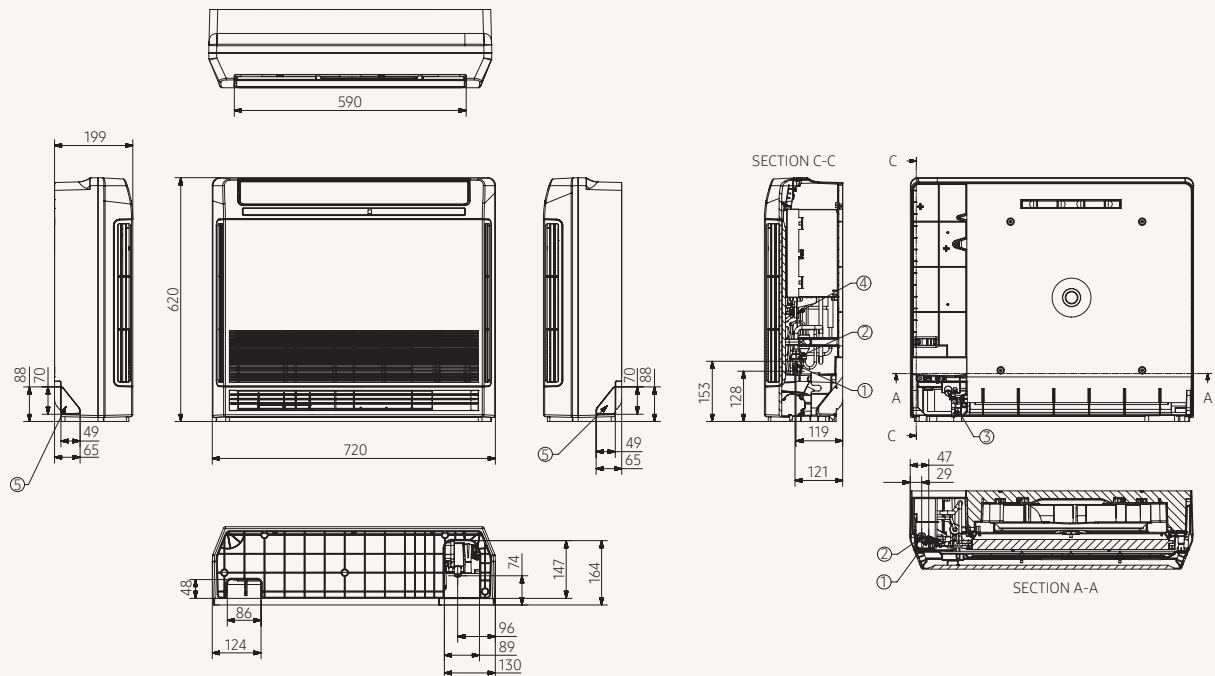

NO	Name	Description
1	Liquid pipe connection	Φ6.35(1/4)
2	Gas pipe connection	Φ12.7(1/2)
3	Drain pipe connection	ID 18mm[11/16 inch] Hose
4	Power supply & Communication wiring conduit	-
5	Knockout hole for drain hose	-

Wall-Mounted Hydro Unit

AE090/160BNVD*H/EU

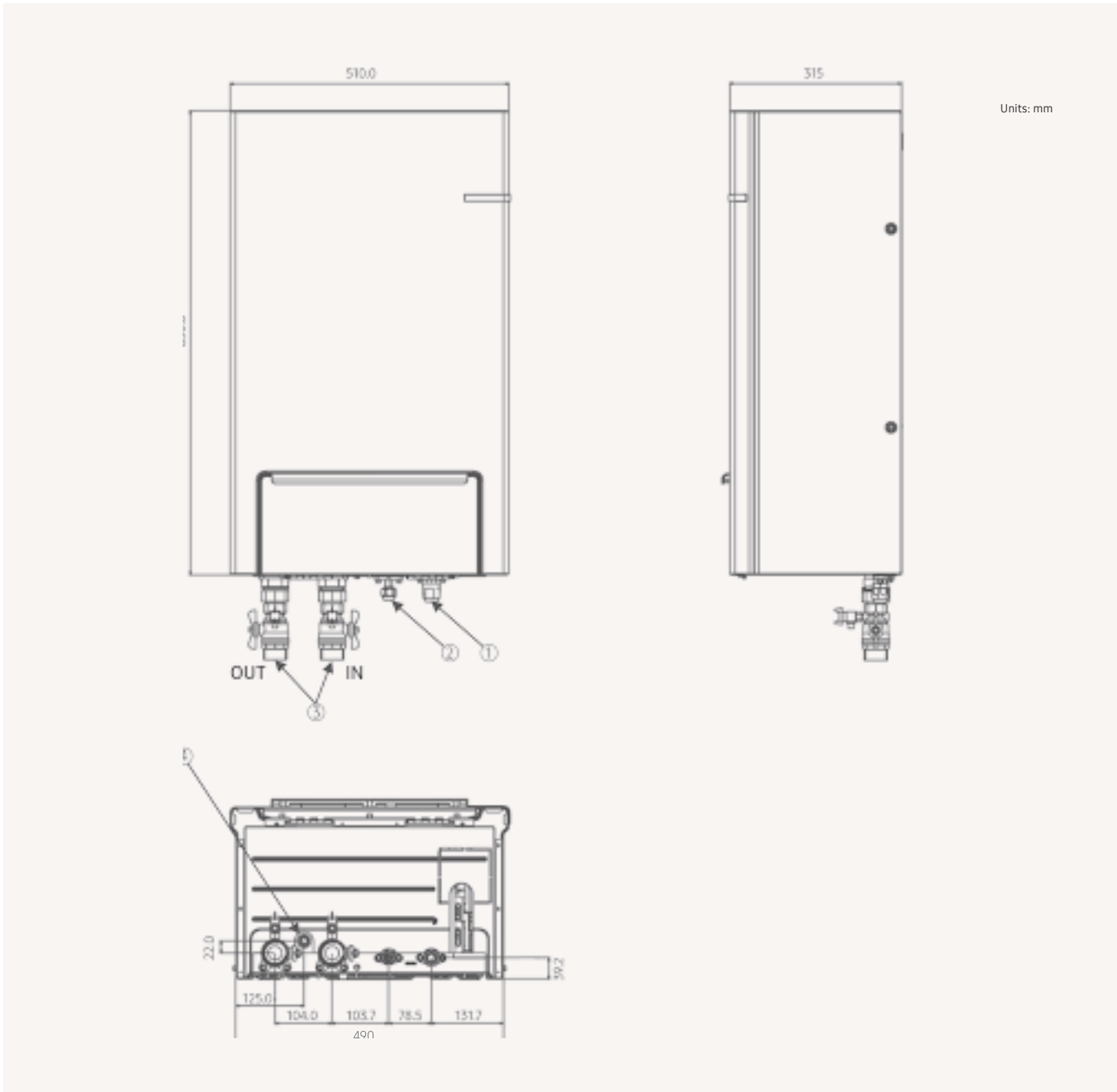

NO	Name	Description
1	Gas Ref. Pipe	ϕ 6.35 (1/4") (9kW), ϕ 9.52 (3/8) (16kW)
2	Liquid Ref. Pipe	ϕ 15.88 (5/8)
3	Water Pipe (Inlet/Outlet)	BSPP male 11/4
4	Drain Hose Connector	

Renovation Solutions



Specifications

EHS Mono HT Quiet R32

- Production of hot water to a maximum temperature of 70 °C
- Premium Design
- Ideal for renovation applications
- Generates a low noise level (35 db(A))
- 100% Heating Capacity at -25 °C
- SmartThings compatible with optional Wi-Fi kit
- Low Ambient temperature operation
- Easy installation and maintenance



		Indoor Unit		AE200RNWMEG	AE200RNWMEG	AE200RNWMEG	AE260RNWMEG		
		Outdoor Unit		AE080BXYDEG/EU	AE120BXYDEG/EU	AE140BXYDEG/EU	AE080BXYDEG/EU		
		Controller		MIM-E03CN/MIM-E03EN**	MIM-E03CN/MIM-E03EN**	MIM-E03CN/MIM-E03EN**	MIM-E03CN/MIM-E03EN**		
System	Operation	Nominal Capacity	Heating A7/W35 ¹ / A7/W55 ²	kW	8.0/8.0	12.0/12.0	14.0/14.0	8.0/8.0	
			Cooling A35/W18 ¹	kW	8.0	12.0	14.0	8.0	
	Power Input (Nominal)		Heating A7/W35 ¹ / A7/W55 ²	kW	1.600	2.353	2.772	1.600	
			Cooling A35/W18 ¹	kW	1.702	2.637	3.146	1.702	
		COP (Nominal Heating) A7/W35 ¹		W/W	5.00/3.20	5.11/3.40	5.05/3.35	5.00/3.20	
		EER (Nominal Cooling) A35/W18 ¹		W/W	4.71	4.55	4.46	4.71	
		SCOP LWT 35°C/ 55°C		W/W	4.64/3.38	4.90/3.78	4.83/3.75	4.64/3.38	
		Seasonal space heating enr. efficiency η _s LWT 35°C/ 55°C		ETA%	183/132	193/148	190/147	183/132	
		Seasonal Space Heating Eff. Class* LWT 35°C/ 55°C			A+++ / A++	A+++ / A++	A+++ / A++	A+++ / A++	
	Current		MCA	A	26.0	32.0	32.0	26.0	
			MFA	A	28.6	35.2	35.2	28.6	
	Water Flow Rate		Low / Medium temperature	EA	7/48	7/58	7/58	7/48	
		Leaving Water Temperature ³		Heating	°C	15-70	15-70	15-70	15-70
			Cooling	°C	5-25	5-25	5-25	5-25	
	Functions		Smart Grid Ready/PV Enabled	-	•	•	•	•	
		3-Step Quiet Mode	-	•	•	•	•		
		2-zone Control	-	•	•	•	•		
Tank Integrated Hydro Unit	Power Supply		Φ, #, V, Hz	1Φ, 2, 220-240 V, 50 Hz	1Φ, 2, 220-240 V, 50 Hz	1Φ, 2, 220-240 V, 50 Hz	1Φ, 2, 220-240 V, 50 Hz		
	Water Tank Volume		litres	200	200	200	260		
	Declared Load Profile		L/XL	L	L	L	XL		
	Average water heating efficiency η _{wh}		ETA%	115	110	110	123		
	Average Energy Efficiency Class		-	A	A	A	A		
	Sound	Sound Pressure ⁴		Heating Std	dB(A)	26	30	30	26
				Cooling Std	dB(A)	26	30	30	26
			Sound Power	Heating Std	dB(A)	40	44	44	40
	Heater	Back-up heater Capacity	Default (Option)	kW	2 (4/6)	2 (4/6)	2 (4/6)	2 (4/6)	
	Piping	Water Pipe (Space Heating)	Inlet/Outlet	Φ, mm	28/28	28/28	28/28	28/28	
Water pipe (DHW)		Inlet/Outlet	Φ, mm	22/22	22/22	22/22	22/22		
Dimensions	Net Weight		kg	130.0	130.0	130.0	140.0		
	Net Dimensions (WxHxD)		mm	595 x 1,800 x 700	595 x 1,800 x 700	595 x 1,800 x 700	595 x 1,800 x 700		
Outdoor Unit	Power Supply		Φ, V, Hz	1Φ, 2Line, 220-240V, 50Hz	1Φ, 2Line, 220-240V, 50Hz	1Φ, 2Line, 220-240V, 50Hz	1Φ, 2Line, 220-240V, 50Hz		
	Compressor	Type	-	Scroll	Scroll	Scroll	Scroll		
	Base Heater	Capacity		kW	0.15	0.15	0.15		
	Sound	Sound Pressure ⁴		Heating Std	dB(A)	42	46	47	42
				Cooling Std	dB(A)	42	46	47	42
			Sound Power	Heating Std	dB(A)	56	59	60	56
	Dimensions	Net Weight		kg	131.2	141.2	141.2	131.2	
		Net Dimensions (WxHxD)		mm	1270 x 1018 x 530	1270 x 1018 x 530	1270 x 1018 x 530	1270 x 1018 x 530	
	Refrigerant	Type			R32 (Fluorinated greenhouse gas, GWP=675)				
		Factory Charging		tCO ₂ e	1.82	2.23	2.23	1.82	
				kg	2.7	3.3	3.3	2.7	
	Piping	Water Pipe (Space Heating)	Inlet/Outlet	Φ, mm	28/28	28/28	28/28	28/28	
Operation	Ambient Temperature		Heating	°C	-30-43	-30-43	-30-43	-30-43	
			Cooling	°C	10-46	10-46	10-46	10-46	
			DHW	°C	-30-43	-30-43	-30-43	-30-43	

Accessories



Touch Controller	Touch Controller	Mono Control Kit	DMS2.5	Wi-Fi Kit	External Room Sensor	Backup Heater (4/6kW)
MWR-WW10*N	MCM-A300N	MIM-E03CN/MIM-E03EN**	MIM-D01AN	MIM-H04EN	MRW-TA	MHC-*00FE



AE260RNWMEG AE120BXYDEG/EU MIM-E03CN/MIM-E03EN**	AE260RNWMEG AE140BXYDEG/EU MIM-E03CN/MIM-E03EN**	AE260RNWMEG AE080BXYDGG/EU MIM-E03CN/MIM-E03EN**	AE260RNWMEG AE120BXYDGG/EU MIM-E03CN/MIM-E03EN**	AE260RNWMEG AE140BXYDGG/EU MIM-E03CN/MIM-E03EN**
12.0/12.0	14.0/14.0	8.0/8.0	12.0/12.0	14.0/14.0
12.0	14.0	8.0	12.0	14.0
2.353	2.772	1.600	2.353	2.772
2.637	3.146	1.702	2.637	3.146
5.11/3.40	5.05/3.35	5.00/3.20	5.11/3.40	5.05/3.35
4.55	4.46	4.71	4.55	4.46
4.90/3.78	4.83/3.75	4.64/3.38	4.90/3.78	4.83/3.75
193/148	190/147	183/132	193/148	190/147
A+++ / A++	A+++ / A++	A+++ / A++	A+++ / A++	A+++ / A++
32.0	32.0	16.1	16.1	16.1
35.2	35.2	17.7	17.7	17.7
7/58	7/58	7/48	7/58	7/58
15-70	15-70	15-70	15-70	15-70
5-25	5-25	5-25	5-25	5-25
•	•	•	•	•
•	•	•	•	•
•	•	•	•	•
1Φ, 2, 220-240 V, 50 Hz	1Φ, 2, 220-240 V, 50 Hz	3Φ, 4, 380-415 V, 50 Hz	3Φ, 4, 380-415 V, 50 Hz	3Φ, 4, 380-415 V, 50 Hz
260	260	260	260	260
XL	XL	XL	XL	XL
117	117	123	117	117
A	A	A	A	A
30	30	26	30	30
30	30	26	30	30
44	44	40	44	44
2 (4/6)	2 (4/6)	6	6	6
28/28	28/28	28/28	28/28	28/28
22/22	22/22	22/22	22/22	22/22
140.0	140.0	140.0	140.0	140.0
595 x 1,800 x 700	595 x 1,800 x 700	595 x 1,800 x 700	595 x 1,800 x 700	595 x 1,800 x 700
1Φ, 2Line, 220-240V, 50Hz	1Φ, 2Line, 220-240V, 50Hz	3Φ, 4Line, 380-415V, 50Hz	3Φ, 4Line, 380-415V, 50Hz	3Φ, 4Line, 380-415V, 50Hz
Scroll	Scroll	Scroll	Scroll	Scroll
0.15	0.15	0.15	0.15	0.15
46	47	42	46	47
46	47	42	46	47
59	60	56	59	60
141.2	141.2	131.2	141.2	141.2
1270 x 1018 x 530	1270 x 1018 x 530	1270 x 1018 x 530	1270 x 1018 x 530	1270 x 1018 x 530
R32 (Fluorinated greenhouse gas, GWP=675)				
2.23	2.23	1.82	2.23	2.23
3.3	3.3	2.7	3.3	3.3
28/28	28/28	28/28	28/28	28/28
-30-43	-30-43	-30-43	-30-43	-30-43
10-46	10-46	10-46	10-46	10-46
-30-43	-30-43	-30-43	-30-43	-30-43



The Quiet Mark is applicable for UK & EU territories only.



* A+++ energy label is available according to EU No. 811/2013 label classification 2019, on a scale from D to A+++

** MIM-E03EN has additional features: Smart Grid ready/ PV Enabled/2-Zone control

¹ A2W Condition: (Heating) Water In/Out 30°C/35°C, Outdoor Air 7°C[DB]/6°C[WB]; (Cooling) Water In/Out 23°C/18°C, Outdoor Air 35°C[DB].

² A2W Condition: (Heating) Water In/Out 47°C/55°C, Outdoor Air 7°C[DB]/6°C[WB].

³ 65°C down to +10°C (max. 60°C down to -5°C)

⁴ Sound pressure level is obtained in an anechoic room. Sound pressure level is a relative value, depending on the distance and acoustic environment. Sound pressure level may differ depending on operation conditions.

Dimensional drawings

EHS Mono HT Quiet

AE080/120/140BXYD*G/EU

Units: mm

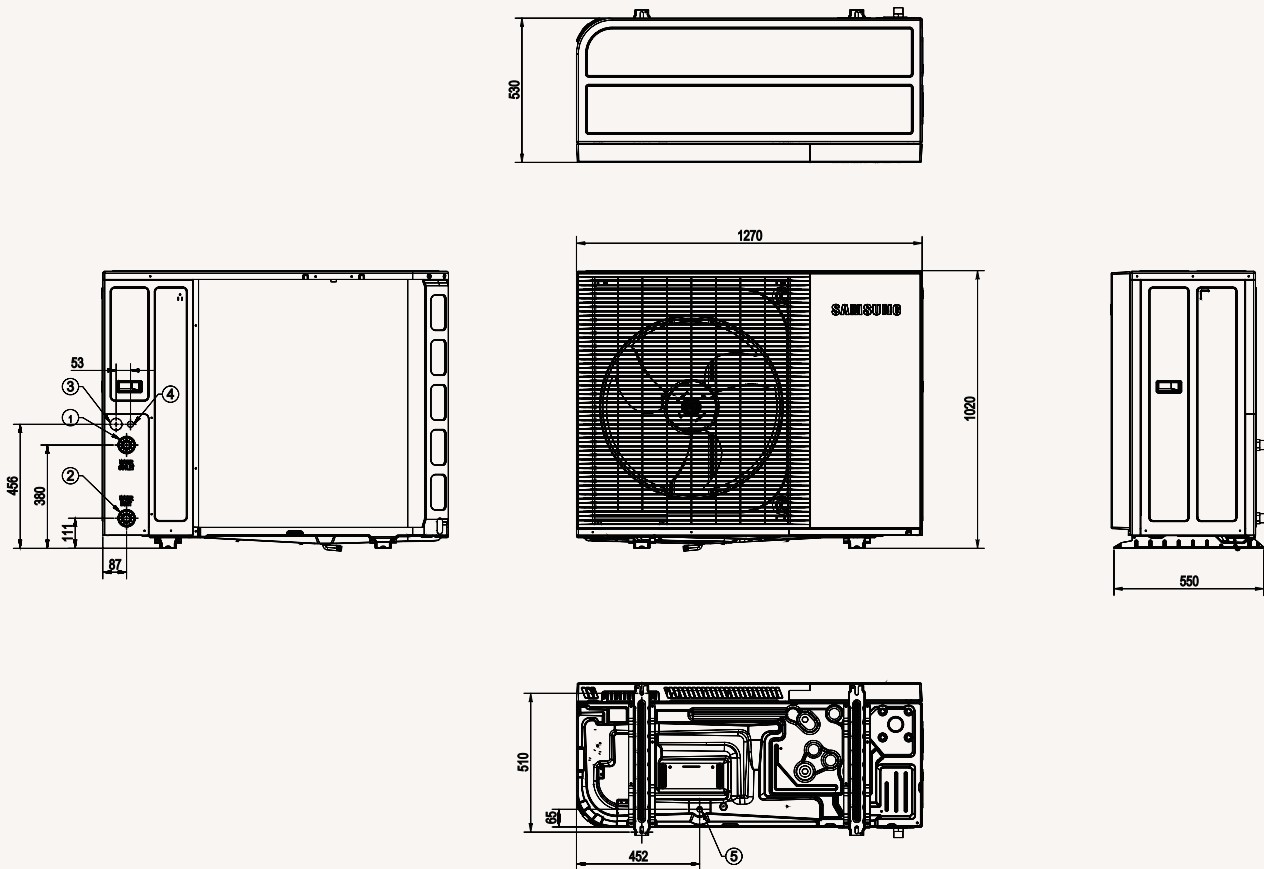

NO	Name	Description
1	Water pipe (Out)	BSPP male 1"
2	Water pipe (In)	BSPP male 1"
3	Power wiring conduit	ø44
4	Communication wiring conduit	ø22
5	Drain holes	Connect with the provided drain plug.



Alternative Heating Solutions





Specifications



DVM S Eco Hydro Split (R410A)

- Production of hot water to a maximum temperature of 80 °C.
- 2-zone control, suitable for floor heating and radiators.
- Ideal for renovation applications.
- Energy monitoring through touch controller.
- Intuitive, colour screen touch controller in multiple languages.
- SmartThings compatible with optional Wi-Fi kit.

¹ Performances are based on the following test conditions:

- Cooling: Indoor temperature: 27 °C DB, 19 °C WB, Outdoor temperature: 35 °C DB, 24 °C WB
- Heating: Indoor temperature: 20 °C DB, 15 °C WB, Outdoor temperature: 7 °C DB, 6 °C WB
- Equivalent refrigerant piping: 7.5 m, Level differences: 0 m

² Sound pressure level is obtained in an anechoic room. Sound pressure level is a relative value, depending on the distance and acoustic environment. Sound pressure level may differ according to operating conditions. Sound power level is an absolute value that a sound source generates.

³ODU: Outdoor Unit, IDU: Indoor Unit



		Model (HT)		AM160TNBFEB/EU	AM250TNBFGB/EU	
		Model		AM050*XMDEH/EU	AM080*XMDDH/EU	
		Controller		MWR-WG00*N	MWR-WG00*N	
System	Operation	HP	HP	5	8	
		Nominal Capacity	Heating ¹	kW	14.0	25.0
		Cooling ¹	kW	14.0	22.4	
	Power Input (Nominal)	Heating ¹	kW	3.40	4.88	
		Cooling ¹	kW	4.00	5.72	
	COP (Nominal Heating)		W/W	TBD	TBD	
	EER (Nominal Cooling)		W/W	TBD	TBD	
	SCOP LWT 35°C/ 55°C		W/W	-	-	
	Seasonal space heating enr. efficiency ηs LWT 35°C/ 55°C		ETA%	TBD	TBD	
	Seasonal Space Heating Eff. Class LWT 35°C/ 55°C		-	TBD	TBD	
	Water flow rate		Low 35°C temp	l/min	23	36
	Current	MCA	A	27.0	18.0	
		MFA	A	40	25	
	Leaving Water Temperature ³		Heating	°C	25.0-80.0	25.0-80.0
	Functions	Smart Grid Ready/ PV Enabled		-	•	•
3-Step Quiet Mode		-	-	-		
2-zone Control		-	•	•		
Hydro Unit HT	Power Supply	MCA (Including External Contact)		Φ, #, V, Hz	1Φ, 2, 220-240 V, 50 Hz	3Φ, 4, 380-415 V, 50 Hz
		MFA			18.0	16.1
		MFA			25.0	20.0
	Sound	Sound Pressure ²	Heating Std	dB(A)	42	42
			Cooling Std	dB(A)		
		Sound Power	Heating Std	dB(A)	60	60
	Dimensions	Net Weight		kg	104	104
		Net Dimensions (WxHxD)		mm	518 x 1.210 x 330	518 x 1.210 x 330
	Refrigerant	Type		-	R134A	
		Control Method		-	EEV	EEV
		Factory Charging		kg/tCO ₂ e	2.15/3.07	2.15/3.07
	Piping Connections	Liquid Pipe	Ø, mm		9.52	9.52
			Ø, inch		3/8	3/8
		Gas Pipe	Ø, mm		15.88	15.88
			Ø, inch		5/8	5/8
Operation	Ambient Temperature	Cooling	°C	-	-	
		Heating	°C	-20.0-35.0	-20.0-35.0	
		Hot Water (Main Cooling, HR)	°C	-20.0-35.0 (43.0)	-20.0-35.0 (43.0)	
Outdoor unit	Compressor	Type		-	Twin BLDC Rotary	Inverter Scroll
		Sound	Sound Pressure ²	Heating Std	dB(A)	55
	Cooling Std			dB(A)	57	58
	Sound Power		Heating Std	dB(A)	75	74
	Dimensions	Net Weight		kg	83.5	135.0
		Net Dimensions (WxHxD)		mm	940 x 998 x 330	940 x 1.420 x 330
	Refrigerant	Type			R410A	R410A
		Factory Charging		kg/tCO ₂ e	2.50/5.22	3.70/7.73
	Piping Connections	Liquid Pipe	Ø, mm		9.52	9.52
			Ø, inch		3/8	3/8
		Gas Pipe	Ø, mm		15.88	19.05
			Ø, inch		5/8	3/4
	Piping length (ODU-IDU) ³		Max. (Equiv.)	m	50 (65)	100 (130)
	Piping length (1st Branch - IDU) ³		Max.	m	40	40
	Total piping length (System)		Max.	m	150	300
Level Difference (Outdoor in highest position)		Max.	m	30	30	
Level Difference (Indoor in highest position)		Max.	m	25	30	
Level Difference (IDU-IDU) ³		Max.	m	15	30	
Operation	Ambient Temperature	Heating	°C	-20.0-24.0	-20.0-24.0	
		Cooling	°C	-5.0-48.0	-5.0-48.0	

Dimensional drawings

DVM S Eco Heat Pump

AM050*XMDEH/EU

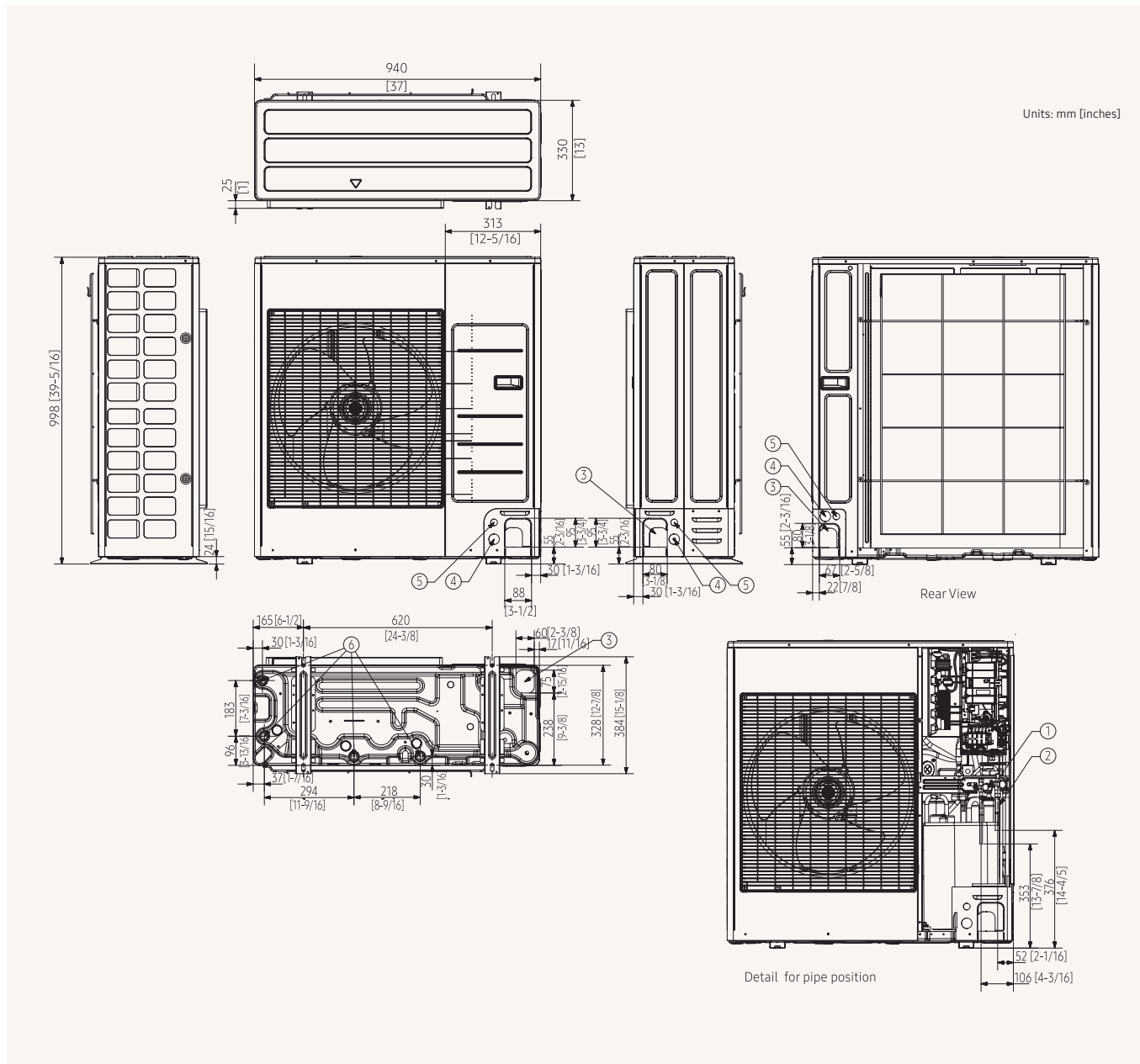

NO	Name	Description
5 hp		
1	Refrigerant liquid pipe	ø9.52 (ø3/8)
2	Refrigerant gas pipe	ø15.88 (ø5/8)
3	Knock-out hole for pipe intake	Front/Side/Rear/Bottom
4	Power wiring conduits	Front/Side/Rear, ø34.00 (ø1 3/8)
5	Communication wiring conduits	Front/Side/Rear, ø22.00 (ø7/8)
6	Drain holes	Connect with the provided drain plug.

Dimensional drawings

DVM S Eco Heat Pump

AM080*XMDGH/EU

Units: mm [inches]

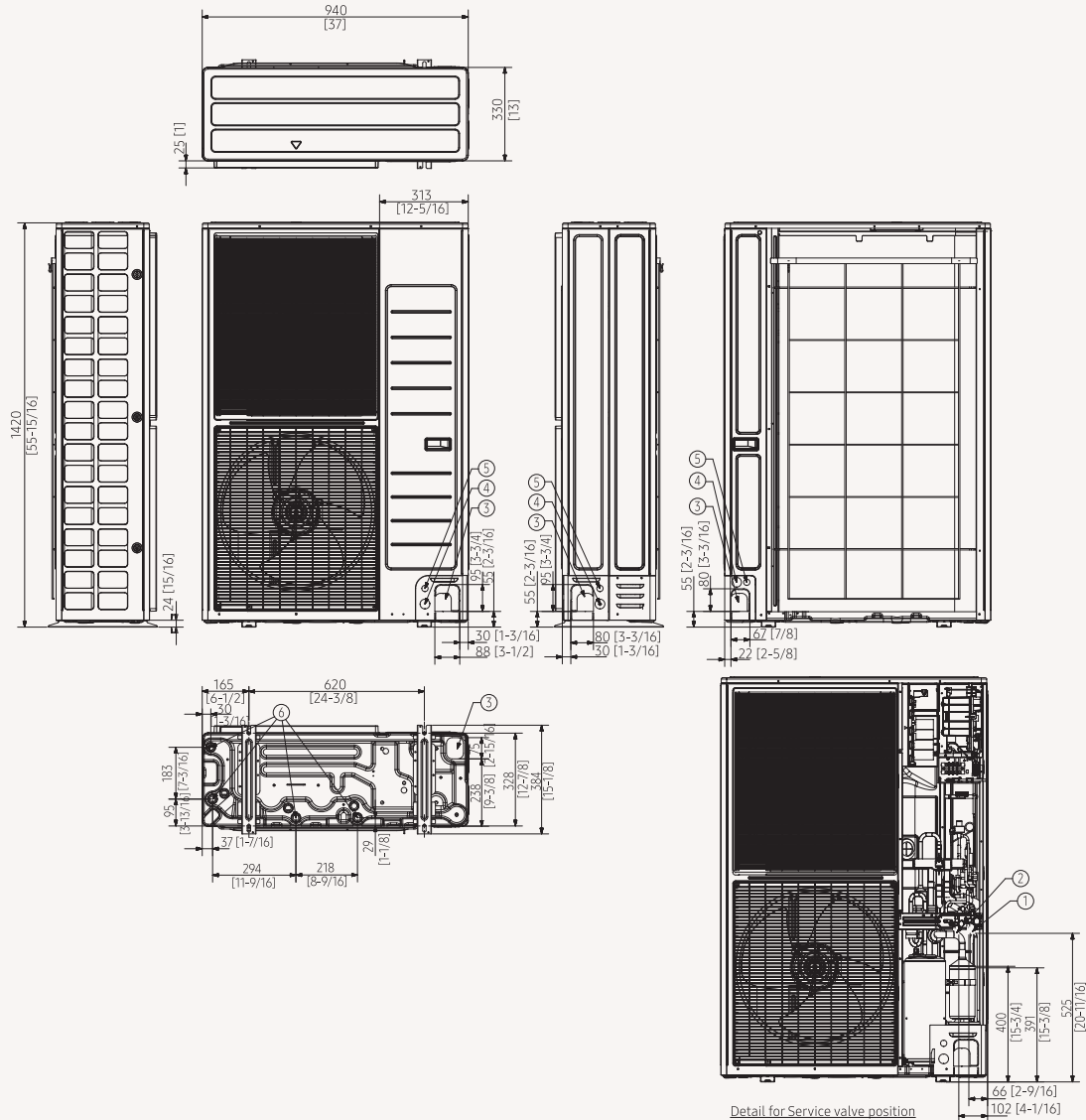

NO	Name	Description
8 hp		
1	Refrigerant gas pipe	ø19.05 (ø3/4)
2	Refrigerant liquid pipe	ø9.52 (ø3/8)
3	Knock-out hole for pipe intake	Front/Side/Rear/Bottom
4	Power wiring conduits	Front/Side/Rear, ø34.00 (ø1 3/8)
5	Communication wiring conduits	Front/Side/Rear, ø22.00 (ø7/8)
6	Drain holes	Connect with the provided drain plug.

Hydro Unit HT

AM160TNBFEB/EU, AM250TNBFGB/EU

Units: mm

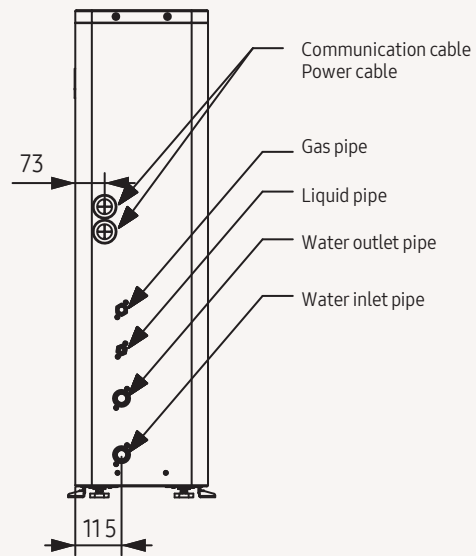
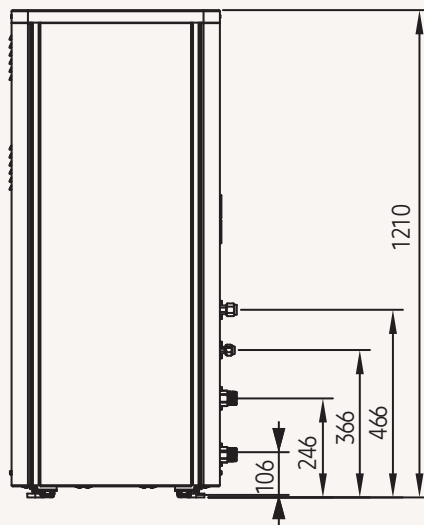
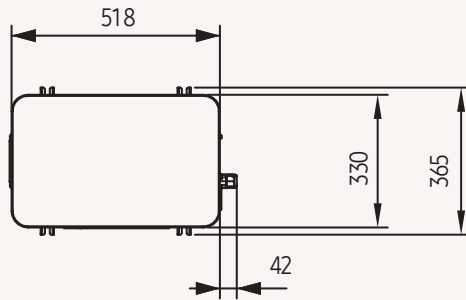

















NO	Name	Description
1	Liquid side connection part	3/8 (ø9.52)
2	Gas side connection part	5/8 (ø22.23)
3	Water side connection part	PT1 (25 A)

Controls



Line-up

Category	Product	Model	Image	Compatibility Table				
				EHS ClimateHub R32		EHS with Third Party Tank		
				EHS Mono R32	EHS Split R32	EHS Mono R32	EHS Split R32	EHS Split R410A
Individual Control System	Wireless Remote Controller	AR-EH03E						
		MR-EH00						
	Wired Remote Controller	MWR-WW10*N		•	•	•	•	•
		MWR-WW00N						
		MWR-WG00*N						
	Touch Controller	MWR-SH11N						
Mono Control Kit	MIM-E03CN/ MIM-E03EN**		•		•			
Centralised Control System	Touch Controller	MCM-A300N		•	•	•	•	•
	Wi-Fi Kit 2.0	MIM-H04EN		•	•	•	•	•
Integrated Control System	DMS 2.5	MIM-D01AN		•	•	•	•	•
	b.iIoT	MST-BL1A		•	•	•	•	•
Interface Module & Gateway	External Contact Interface Module	MIM-B14				•	•	•
	Pulse Interface Module (PIM)	MIM-B16N		•	•	•	•	•
	Modbus Interface module	MIM-B19N		•	•	•	•	•
Others	S-Converter	MIM-C02N		•	•	•	•	•
	External room sensor	MRW-TA		•	•	•	•	•
	Receiver Kit	MRK-A10N						

Features

Controls | Individual Control

Wireless / Wired Remote Controllers		
<p>Wireless Remote Controller Standard with WindFree™</p> <p>AR-EH03E</p>		<ul style="list-style-type: none"> • WindFree™ On/Off • Filter replacement alarm reset • Simple On/Off timer • Indoor unit option code setting • Temperature setting range • Auto/Cool/Dry : 18°C - 30°C • Heat : 16°C - 30°C • Direct/Indirect function On/Off • Motion Detect Sensor necessary • Net dimensions (W x H x D): 48 x 138 x 24mm
<p>Wired Remote Controller Standard type for EHS</p> <p>MWR-WW10*N</p>		<ul style="list-style-type: none"> • Full color 4.3" LCD screen • Easy and Intuitive UI • 2-zone Control • LCD Backlight • Multiple Language support* • IR receiver is included • Daylight Savings Time • °C / °F Convertible • Error list display • Built-in room temperature sensor • SD slot • Net dimensions (W x H x D): 120 x 120 x 19mm <p>* Available languages: English, German, Spanish, French, Italian, Polish, Portuguese, Dutch, Greek, Czech, Slovak, Finnish, Swedish, Norwegian, Danish and Lithuanian.</p>
<p>Wired Remote Controller</p> <p>MWR-WG00*N</p>		<p>Air conditioner/ERV control</p> <ul style="list-style-type: none"> • AC control: ON/OFF, operation mode, temperature setting, fan speed, airflow direction • ERV control: ON/OFF, operation mode, fan speed • AC/ERV error monitoring • Filter cleaning alert and reset alert time • Control a maximum of 16 "Indoor unit + ERV" in a group with a single wired controller <p>Energy saving operation</p> <ul style="list-style-type: none"> • Upper/lower temperature limit setting • Automatically stops operating when not used for certain period of time as set by user <p>Weekly operation schedule setting</p> <ul style="list-style-type: none"> • Weekly operating schedule (A/C only, ERV only, A/C+ERV) • Set desired AC operation mode, temperature and fan speed to operate based on a weekly schedule • Apply schedule exception day • Energy consumption monitoring • Operation time limit <p>User convenience function</p> <ul style="list-style-type: none"> • Child lock • Different button permission levels • Room temperature display • Dual set point • Built-in room temperature sensor • Real-time clock: displays current time and day (summer time support) • Multiple language support • Service mode support • Indoor unit cycle data monitoring • Indoor unit option code setting and monitoring • Indoor unit address setting and monitoring • SD card slot
<p>Wired Remote Controller</p> <p>MWR-WW00N</p>		<ul style="list-style-type: none"> • Air conditioner/ERV operation setting (Horizontal air flow, WindFree™) • LCD Backlight • Air conditioner/ERV error monitoring • Air conditioner individual blade control • Filter cleaning alert/reset alert time • Air conditioner/ERV interlocking control • Energy saving control • Automatic operation stop function • Weekly operation schedule setting • Button restriction function • Built-in room temperature sensor • Real time clock (Daylight Savings Time) • Control max. 16 indoor units (Air conditioner + ERV) in group with single wired remote controller • Net dimensions (W x H x D): 120 x 124 x 19.5mm

<p>Wired Remote Controller Touch Simple type</p> <p>MWR-SH11N</p>		<ul style="list-style-type: none"> • Touch screen wired remote controller • LCD Backlight • IR receiver is included • Away function • Quiet mode, Sleep mode • Reset filter cleaning alert indicator • Air conditioner Individual/group control • Operation On/Off timer function • WindFree™/Long horizontal wind • Button locking function • Eliminate Operation Mode function : Auto/Cool/Dry/Fan/Heat mode • Built-in room temperature sensor • °C / °F Convertible • Relative temperature setting function : -3 ~ +3°C setting • Control max. 16 indoor units in group with a single wired remote controller • Net dimensions (W x H x D): 94.2 x 122 x 19.5mm
<p>Mono Control Kit</p> <p>MIM-E03CN/MIM-E03EN</p>		<ul style="list-style-type: none"> • EHS R32 Mono control Kit • Includes remote controller (MWR-WW10N) and flow sensor • Mounting box with the control printed board assembly • Leaving and return water sensors • Domestic Hot Water sensor • Net Dimensions (WxHxD) mm 290 x 110 x 370 mm • MIM-E03EN has additional features: Smart Grid ready/PV enabled/2-Zone control

Controls | Centralised Control

Centralised Control Systems		
<p>Touch Controller</p> <p>MCM-A300N</p>		<ul style="list-style-type: none"> • 7 inch touch LCD controller • Controls max. 128 indoor units • Controls max. 12 zones • Schedule control, Indoor unit usage restriction, View indoor unit error history • Net dimensions (W x H x D): 205 x 163 x 38mm
<p>Wi-Fi Kit 2.0</p> <p>MIM-H04EN</p> <p> Bixby</p> <p> SmartThings</p>		<ul style="list-style-type: none"> • Enhanced Convenience • Voice Control available through a smartphone with Bixby • Connected home with affordable units in every home using SmartThings • Welcome cooling and heating based on Geo-fencing • Individual indoor unit control • Personalized Climate Environment • Preferred automation • Multi-device experience interoperable with smart appliances • Energy Usage Monitoring • Current and daily, weekly or monthly energy usage* of the outdoor unit • Provides ease of installation • Easy set-up possible for up to 16 indoor units at once • Net dimensions (W x H x D): 185 x 130 x 29mm



* Calculated by Samsung's own algorithm, it cannot be used as a legal basis.

Features



Controls | Integrated Control

Integrated Control Systems		
<p>DMS2.5</p> <p>MIM-D01AN</p>		<ul style="list-style-type: none"> • Built-in web server for PC-independent management and remote access control • Multiple upper-layer control access (S-NET 3, Web-client) • Weekly/Daily schedule control • Power distribution function • Current time management even during power failure (for 24 hours) • Emergency stop function with simple contact interface • Individual/Group control of up to 256 indoor units, AHU and ERV • User editable control logic • Accessible level management. • Dynamic security management • Operation & error history management • Data storage in non-volatile memory & SD memory • Net dimensions (W x H x D): 240 x 255 x 65mm

Controls | Interface devices

Module, Application Kit, Gateway		
<p>External Contact Interface Module</p> <p>MIM-B14</p>		<p>The Samsung Guestroom Management System saves users the energy and money wasted on cooling an unoccupied room. The air conditioner is activated when the Key-Tag is in place and turns off when the Key-Tag is removed.</p> <p>An external contact interface module provides direct indoor unit control via an external contact signal, as well as window-synchronised indoor unit control. The emergency control function features simple contact input. Plus the module generates indoor unit operation/error state output through relay contacts.</p> <ul style="list-style-type: none"> • Direct indoor unit control by external contact signal • Window-synchronised indoor unit control • Emergency control with simple contact input • Indoor unit operation/error state output through relay contacts • Net dimensions (W x H x D): 50 x 80 x 35mm
<p>Modbus Interface Module</p> <p>MIM-B19N</p>		<p>A BMS or 3rd controller can control a Samsung SAC by using the Modbus protocol.</p> <ul style="list-style-type: none"> • BMS unit protocol: Modbus RS485 (2 wires, max. 1,000m) • Unit connection protocol: Samsung Control Layer Protocol (R1/R2) • Max. No. of connection units: 1 outdoor unit (4 outdoor units including sub units in the case of modular installation) and 48 indoor units • Modbus interface module address range : up to 247 • Net dimensions (W x H): 50 x 80mm
<p>Pulse Interface Module (PIM)</p> <p>MIM-B16N</p>		<p>The Watt-hour Meter Interface Module can be exclusively used for DMS 2.5 power distribution, displaying power consumption for each watt-hour meter.</p> <ul style="list-style-type: none"> • Exclusive use for DMS 2.5 power distribution • Connection with up to 8 watt-hour meters • Pulse interface with watt-hour meters • Watt-hour meter - by 3rd party • Net dimensions (W x H x D): 240 x 255 x 65mm

Controls | Others

Module, Application Kit, Gateway		
S-Converter		<p>Communication converting module to connect a Samsung system air conditioner to a PC</p> <ul style="list-style-type: none"> • Main reasons for use: <ul style="list-style-type: none"> - To connect with test run program [Test run program] - S-NET Pro: Conventional communication - S-NET Pro2: New communication • Net dimensions (W x H x D): 66 x 92 x 28mm
External Room Sensor		<ul style="list-style-type: none"> • Indoor unit is operated by MRW-TA instead of its own sensor. • Wire length: 12 m (39 ft)
Receiver Kit		<ul style="list-style-type: none"> • Concealed wireless signal receiver • Filter replacement sign • Fan operation display • Operation Timer setting display • Operation On/Off button • Operation On display LED (blue) • Defrost operation display LED (red) • Net dimensions (W x H x D): 80 x 130 x 28mm









0803-14157A





Accessories

Compatibility

Accessories		Name	Indoor unit	TDM Plus Slim Duct	TDM Plus MSP Duct	TDM Plus WindFree™ Deluxe	TDM Plus Console	Wall-Mounted Hydro Unit	EHS ClimateHub
		Name	Model code	2.2-5.6 kW	7.1-9.0 kW	2.2- 7.1 kW	2.2-5.6 kW	9.0/16.0 kW	200/260 L
EEV Kit (1/2/3 room)		1 Indoor	MEV-E24SA			•			
			MEV-E32SA			•			
		2 Indoor	MXD-E24K132A			•			
			MXD-E24K200A			•			
			MXD-E32K200A			•			
		3 Indoor	MXD-E24K232A			•			
			MXD-E24K300A			•			
			MXD-E32K224A			•			
			MXD-E32K300A			•			
Y-Joint		(≤15.0 kW and below)	MXJ-YA1509M	•	•	•	•	•	
							(TDM Plus only)	(TDM Plus only)	
Drain Pump		Internal	MDP-E075SEE3D	•					
		External	MDP-G075SP		•				
		Internal	MDP-G075SQ		•				
Backup Heater		4 kW	MHC-400FE						•
		6 kW	MHC-600FE						•



Design and support

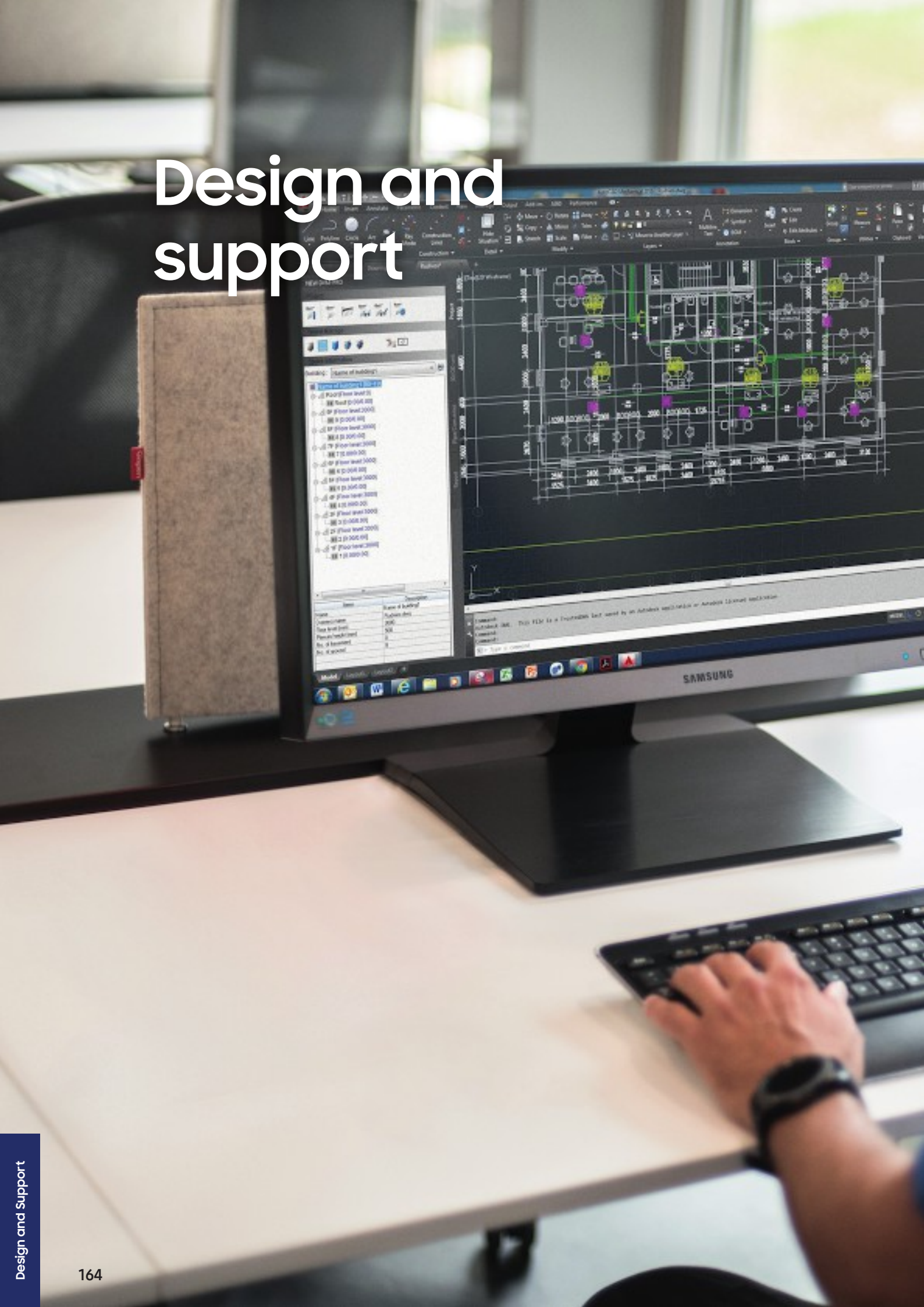



SAMSUNG

Samsung Climate Solutions Partner Portal

As one of Samsung's registered Climate Solutions partners, you will have access to our Partner Portal and its many benefits. Whether you are looking for marketing materials or technical product documentation, requesting technical support or registering for training, the Samsung Climate Solutions Partner Portal offers you everything you need to consistently deliver the best results.

Access technical resources

The Technical Resources section provides you with all of the relevant information you need to understand the product's functionality and to prepare and design projects. A library full of technical information is at your fingertips, ranging from technical data books, BIM files and certificates to exploded views, CAD drawings and user and installation manuals.

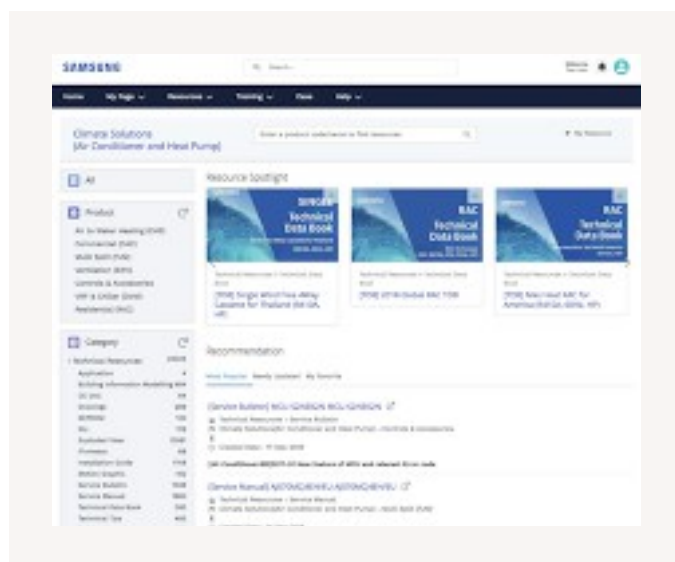

Request technical support

You can easily request technical support through the Samsung Partner Portal by reporting your case using our built-in ticketing system. You can rest assured that our well-trained technical experts will work to solve your issue as soon as possible.

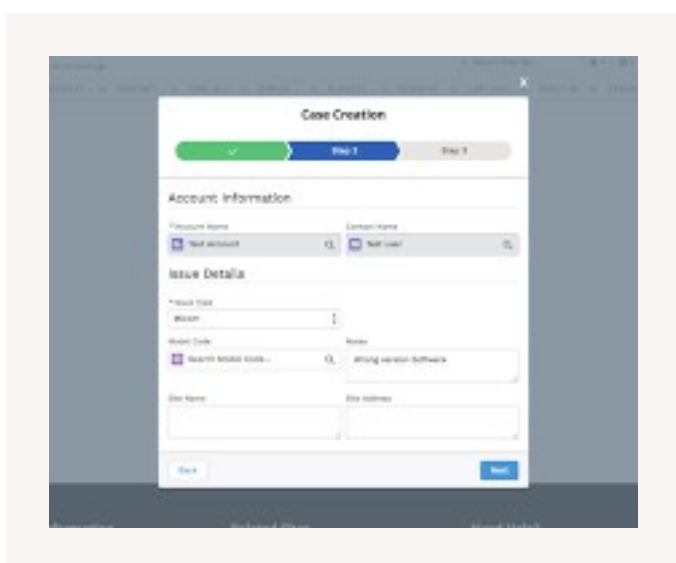

Register for training

If you are dedicated to becoming a Samsung climate solutions expert, you can access Samsung's educational portal for training sessions provided by experienced trainers. The portal allows you to search for online courses and materials, test your climate solutions knowledge, and more. The Samsung Business Academy is here to help you succeed.¹

¹ The registration process for and availability of training courses may vary per country. Please contact your direct Samsung contact person for more information.

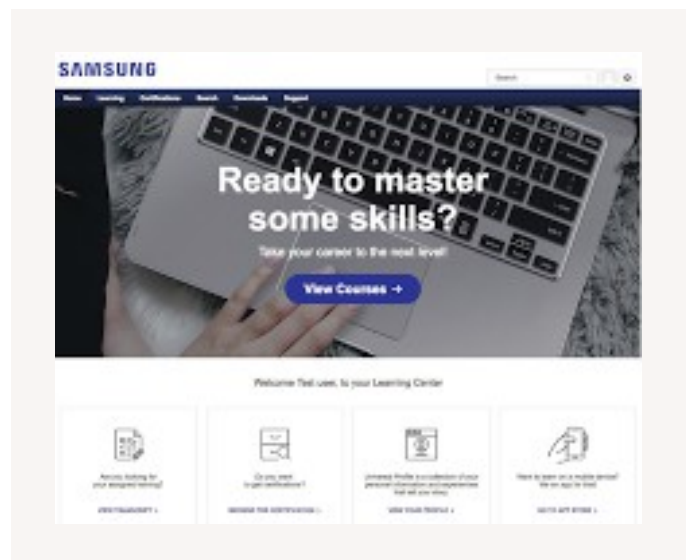

How to access



Register

To register for the Samsung Climate Solutions Partner Portal, open your web browser¹ and go to partnerhub.samsung.com/climate to complete the registration form.



Access

Your information will be verified and your account will be activated. You will receive your personal login details.



Manage account

Keep your account details up to date and invite your colleagues to join.



Search and download

Access a full library of resources, request technical support, or sign up for a Climate Solutions Academy training session.

¹ Google Chrome is the recommended web browser for using the Samsung Climate Solutions Partner Portal.

EHS Selection Software

Samsung EHS Selection Software* is a free of charge, online selection aid for Samsung EHS products. Samsung EHS Selection Software is an advanced design automation program that helps you design your heating system more easily and precisely. You can select the most suitable heating system from the entire range of Samsung EHS products and design the system with its user-friendly interface. It helps to ensure that the system's design complies with Samsung's engineering guidelines.

The ability to calculate the heating load, power consumption, export reports, seasonal efficiency data, water pipe schematics, energy labels and Keymark product fiches and much more makes the EHS Selection Software a powerful tool for an installer, designer and end user.

How to access



Register

The EHS Selection Software is an open web-based platform. No registration process is required.



System Selection

Select the type of EHS system most suitable to your purpose from EHS Mono, EHS Split or EHS TDM PLUS.



Design Conditions

Input your design conditions, heating and cooling loads, DHW consumption.

EHS Selection software can also assist you in calculating heating and DHW loads for your project.



Product Selection

Select the most suitable outdoor unit, indoor unit and accessories based on performance charts provided.



Report

Download the EHS Product selection report in PDF or share the link.

*Available from December 2022 onwards.

System Selection

Select the system configuration based on your requirement.

Select your configuration



Mono

No refrigerant work needed

- The Mono outdoor unit includes the hydrolic system, making it easy to install and saving space.
- Maximum leaving water temperature is 65 °C down to 10°C ambient temperature.
- Compatible with the Samsung ClimateHub or a third party DHW tank.
- Refrigerant R32.

✓

Split

Refrigerant work needed

- The Split outdoor unit is connected to an indoor hydrolic unit.
- Maximum leaving water temperature is 65°C (R32) or 55°C (R410A) down to 10°C ambient temperature.
- Compatible with a third party DHW tank or the Samsung ClimateHub (R32).
- Refrigerant R32 (up to 9 kW), R410A (above 9 kW).



TDM PLUS

Refrigerant work needed, combination with Air-to-Air units

- TDM Plus combines Air-to-Water with Air-to-Air to provide heating and cooling, thus saving space as a single outdoor unit is required.
- Maximum leaving water temperature is 55 °C down to 10°C ambient temperature.
- Compatible with the Samsung ClimateHub or a third party DHW tank.
- Refrigerant R410A.

Continue to Design conditions

Design Conditions

Select the purpose of your water solution and its respective piping length, leave in temperature and Domestic Hot Water Solution.

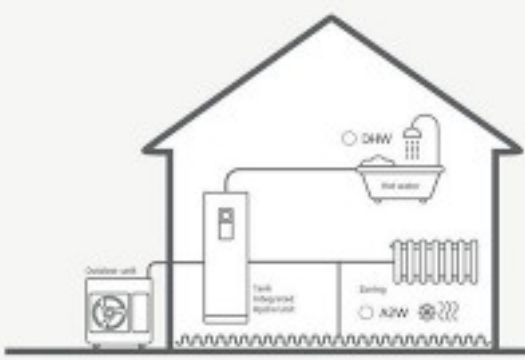

Design conditions

Purpose of your water solution

Heating
Cooling
Heating & Cooling

Longest piping length ⓘ

m

Height difference ⓘ

m

Heating Leaving Water Temperature ⓘ

Fixed
Variable

30 (LWH)

40 (FCU)

55 (Mediators)

75

65

Cooling Leaving Water Temperature ⓘ

Fixed
Variable

10 (FCU)

18 (LWH)

5

25

Choose your DHW solution

Samsung Climate Hub
Third Party Tank
No DHW application

Country City

Netherlands
Amsterdam

← Go back to System selection
Continue to Heating & Cooling loads calculation →

Heating & Cooling loads calculations

Define the expected heating & cooling loads

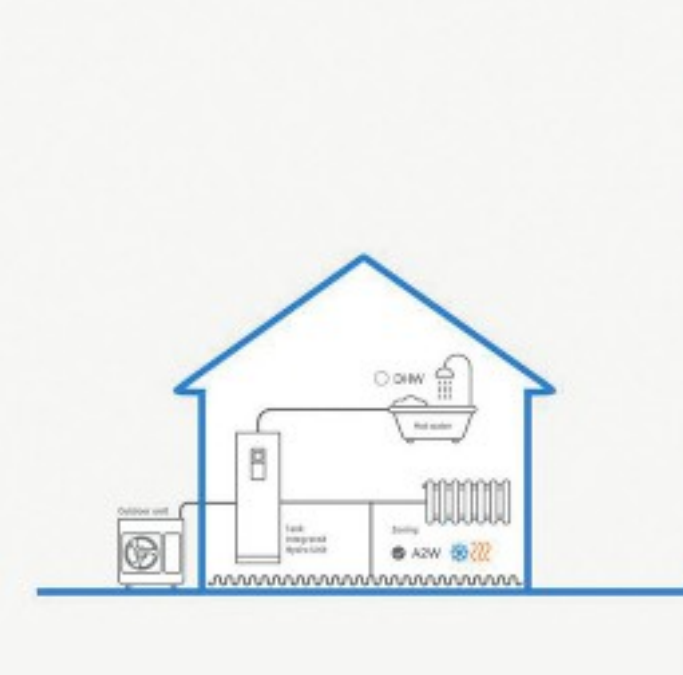

Heating & Cooling loads calculation

Heat load known - no calculation | Simplified calculation | Detailed calculation

Definition type

Define room by room | **Define overall**

Total cooling load: 5 kW

Total heating load: 9 kW

Go back to Design conditions | **Continue to DHW**

Domestic Hot Water (DHW)

Define the expected consumption



DHW

Calculation of energy

Number of occupants	Domestic hot water consumption per occupant
3	45 l/day
Domestic hot water temperature	Water mains input temperature
40 °C	10 °C
Hot water storage temperature	Number of disinfection cycles per month
50 °C	0

Go back to Heating & Cooling loads calculation | **Continue to Product selection**

Product Selection

Select the Outdoor Unit, Indoor Unit and System accessories



Product selection

Indoor unit

[Change product](#)

AE260RNWSEG/EU

Water tank volume	Capacity built-in DHW	Capacity immersion heater	Sound power
260 L	2 kWh	3 kW	40 dB

 SPLIT HYBRID (BWT)
Refrigerant: R32
Nominal capacity(DHW): Capacity 260L
Phase: 10

[See product](#) >

Selected accessories:
MHC-600FE, MWR-WW10N, MWR-WW10DN, MRW-TA, MHC-400FE

[Select accessories](#) >

System accessories

 **Touch Controller**
MCM-A501N [See product](#) >

 **WI-FI KIT 2.0**
MM-H04EN [See product](#) >

[Go back to DHW](#) [Continue to Report](#) →

Report

Download the EHS Product Selection report.



Samsung specialist design support

Bringing together technical expertise and practical experience in climate system design, Samsung provides a single point of contact for the design and management of cooling and heating installations in buildings. With assistance ranging from 3D visualisations with BIM support to CFD analysis to optimise indoor thermal conditions and BREEAM advice to achieve the best environmental performance, Samsung's specialist engineers are ready to support you in making your project a success.

BIM support

Building Information Modelling (BIM) is an intelligent 3D model-based process for creating and managing information on the physical and functional characteristics of a building, across the project lifecycle and covering all parties involved, including the supply chain. BIM gives architects, engineers and construction professionals the insights and tools necessary to efficiently plan, design, construct and manage buildings and infrastructure.

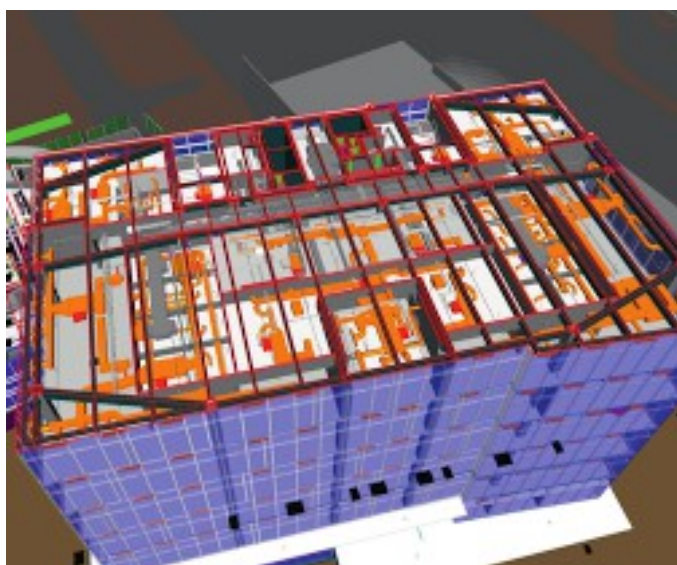
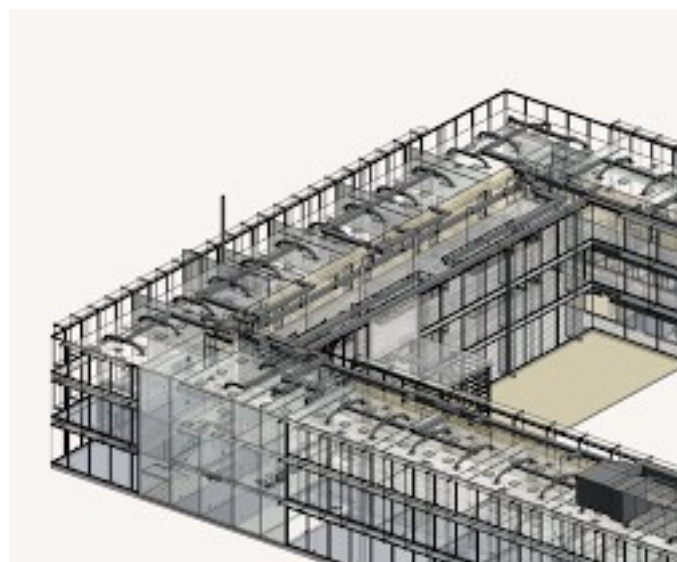

To support you as one of our Climate Solutions partners, Samsung has developed a full range of BIM models for all VRF and VRF Chiller products. You can download these 3D models directly from Samsung Partner Portal or from an online BIM object library by accessing bimobject.com. Alternatively, you can call on our qualified Samsung engineering team for dedicated project design support, using Revit® software to create 3D plans of the building including Samsung air conditioner installations.

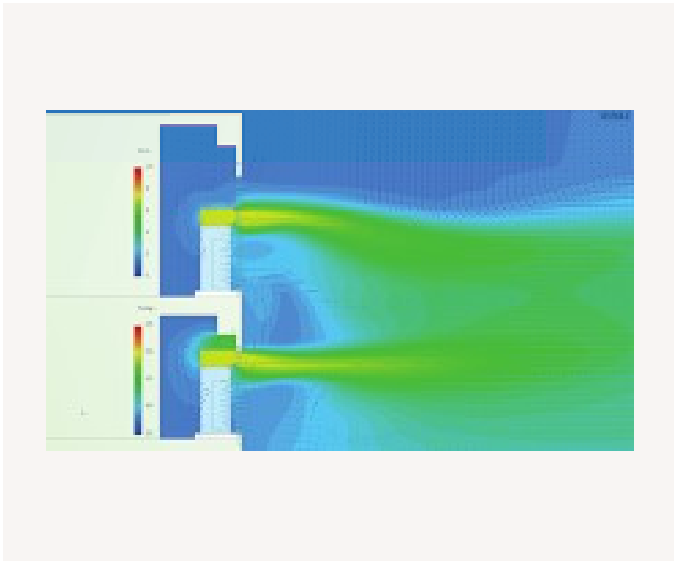

CFD analysis

Computational Fluid Dynamics (CFD) uses numerical analysis and data structures to analyse thermal conditions in buildings. It allows the virtual testing and optimisation of various climate system configurations in the context of occupant comfort, energy efficiency and running cost. Samsung can offer you specialist CFD support that includes analyses such as indoor temperature profiling, airflow distribution and sound simulation.

BREEAM advice

BREEAM (BRE¹ Environmental Assessment Method) is one of the most widely used environmental assessment methods and rating systems for buildings. It sets the standard for best practice in sustainable design and has become the de facto measure used to describe a building's environmental performance. Samsung's Accredited Professionals (APs) can support you in assessing the optimal installation for achieving a high certification score to match your green building programme.

¹BRE (Building Research Establishment) is a leading, multidisciplinary building science centre based in the United Kingdom.



How to obtain support



BIM support

To download Samsung BIM models, go to the Technical Resources on partnerhub.samsung.com/climate¹. To request dedicated project design support from Samsung, please contact your Samsung representative.



CFD analysis

To obtain CFD analysis support from Samsung, please contact your Samsung representative. Certain conditions may apply, subject to the project.



BREEAM evaluations

Please contact your Samsung representative to request a BREEAM evaluation by one of Samsung's Accredited Professionals (APs).

¹ Google Chrome is the recommended web browser for using the Samsung Climate Solutions Partner Portal.

Samsung Climate Solutions Academy

Samsung Climate Solutions Academy is committed to providing engineers with the technical skills required to install a Samsung product efficiently, and to help relay necessary information to users. All courses are designed to provide attendees with the opportunity to develop both theoretical and practical knowledge of Samsung's vast range of equipment and solutions.



Available training modules

Essential courses: Basic commercial training

- The product line-up, accessories and available controls
- The unique features of Samsung products
- Installation considerations

Advanced courses: Technical training

- How to correctly install and configure a system
- Commissioning: common issues during commissioning and how to resolve any challenges
- Troubleshooting and fault-finding (by use of E-codes)
- Control logic
- Case studies

Advanced courses: Design training

- Understanding customers' needs and offering possible solutions
- DVM Pro 2.0 - Samsung's advanced design tool
- Case studies

Note: the registration process for and availability of training courses may vary per country. Please contact your Samsung representative for more information.

Samsung training centres in Europe



How to register for training



Search

To check for available training courses, go to Samsung Business Academy (SBA) via the Samsung Climate Solutions Partner Portal¹: partnerhub.samsung.com/climate. Search the online event calendar and select the training course you would like to attend.



Register

After identifying the training course you would like to attend, follow the registration process. Once you have registered successfully you will receive a confirmation e-mail.



Get certified

Following confirmation of your registration, we will invite you to one of our training centres. You will be trained by one of our specialised Master Trainers or Product Specialists, and receive a Certificate of Completion.

¹ Google Chrome is the recommended web browser for using the Samsung Climate Solutions Partner Portal.

Hydraulic Schematics



ClimateHub Split

Application examples

Application 1: Space heating + water heating

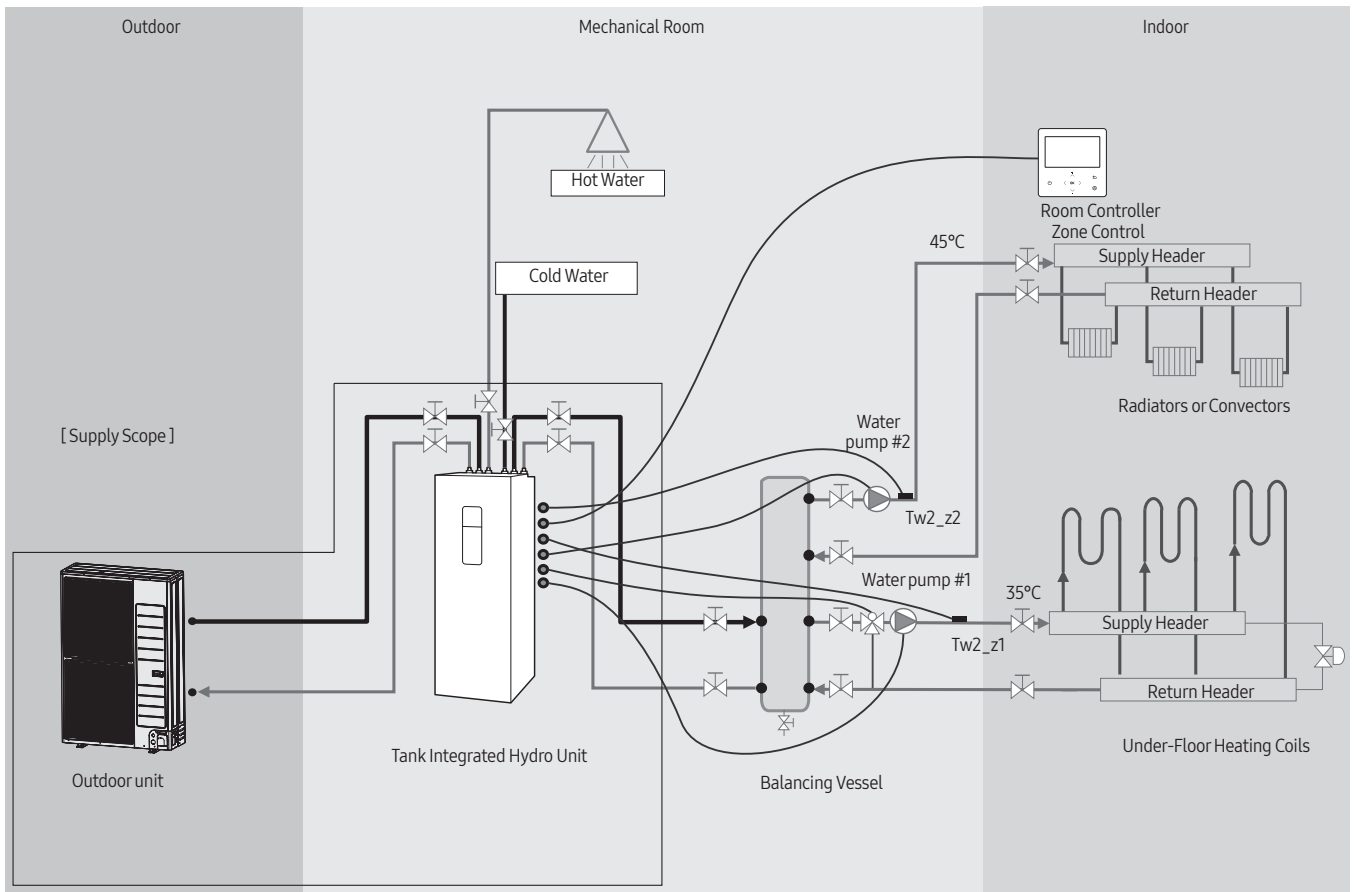

ClimateHub Split

Application examples

Application 2: Hybrid application (backup boiler)

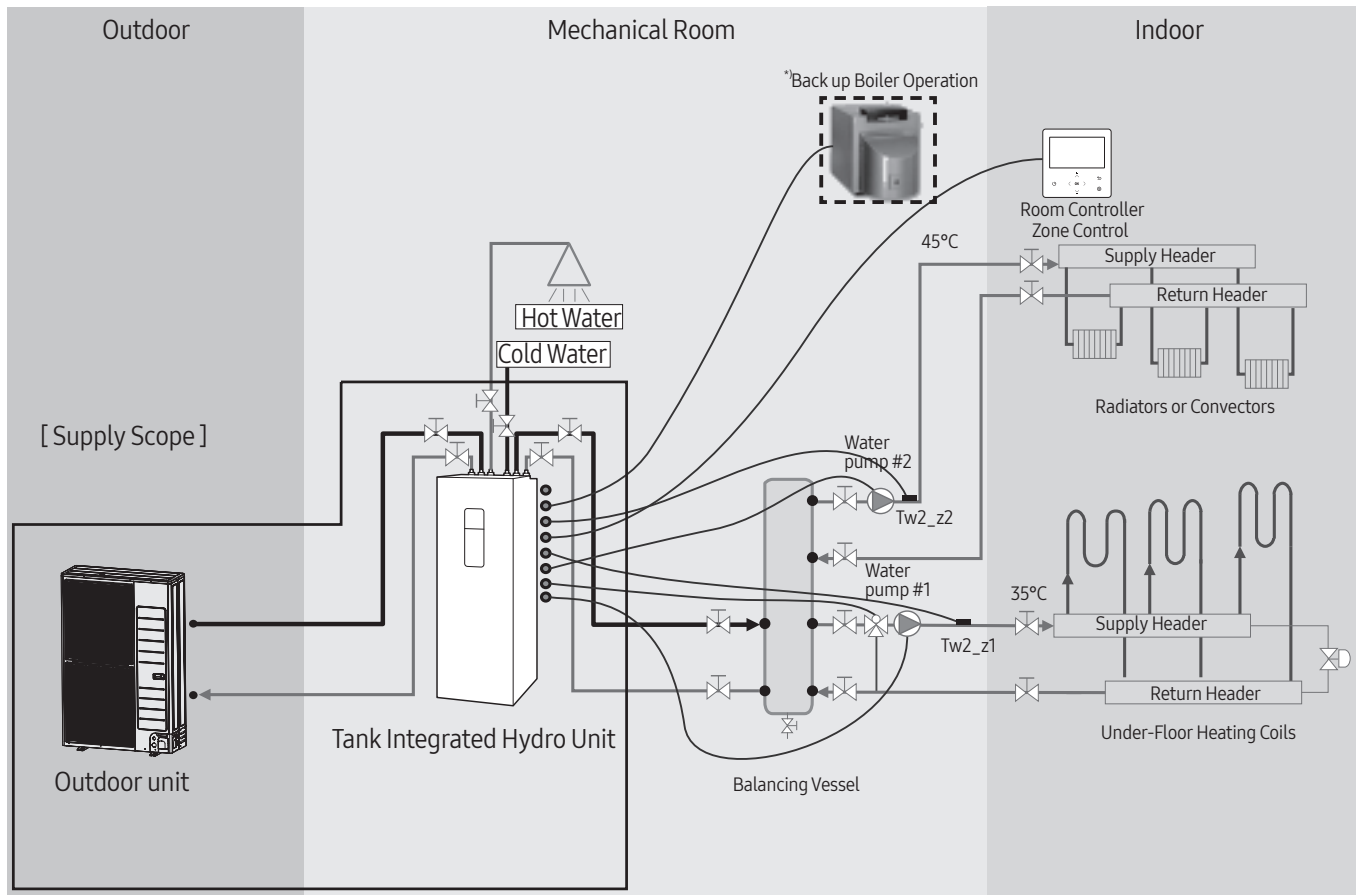

* We control only the on/off signal of backup boiler according to outdoor temperature. Backup boiler should be installed with own device according to the field condition.

ClimateHub Mono

Application examples

Application 3: Space heating + water heating

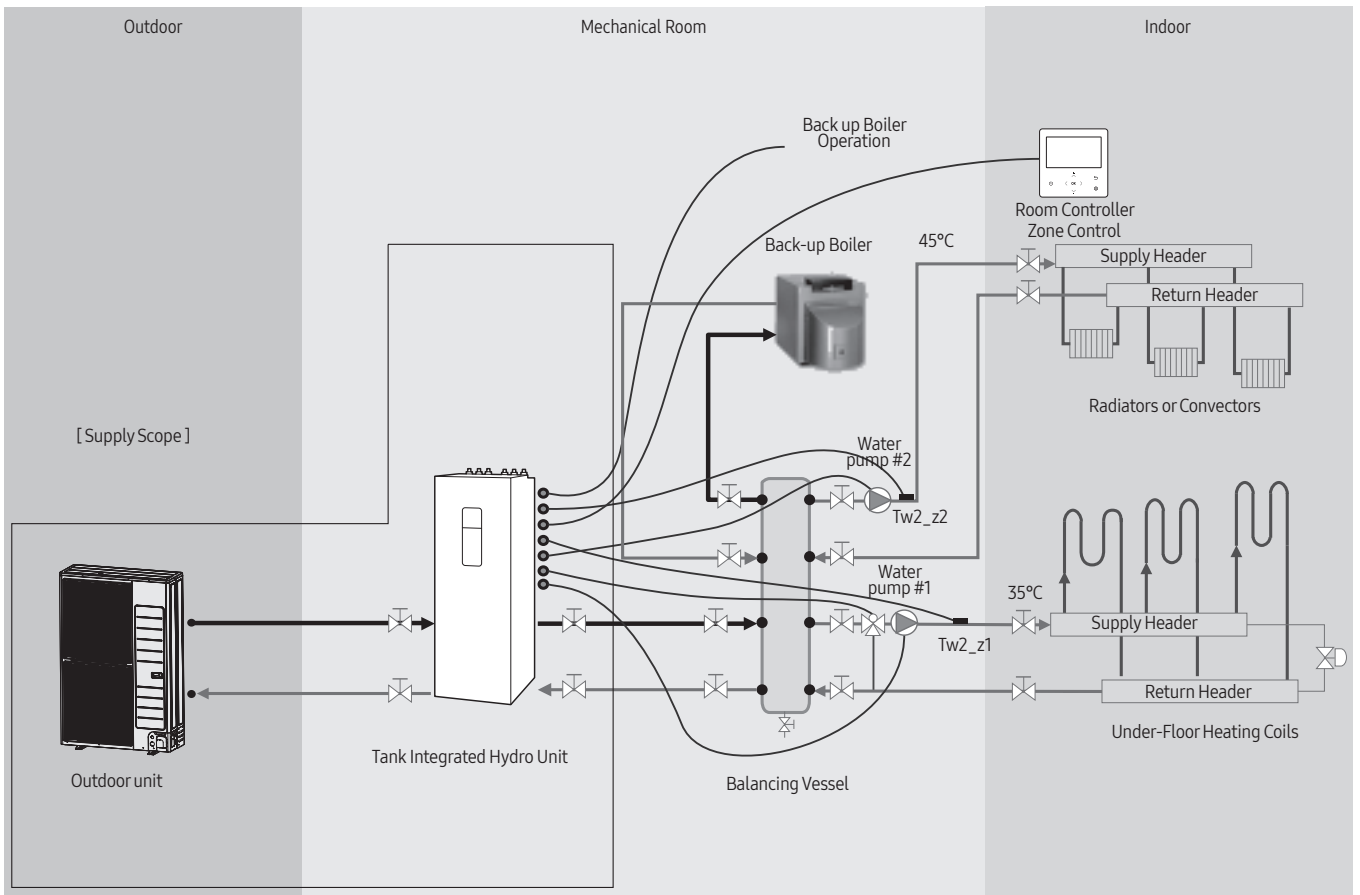

ClimateHub TDM Plus

Application examples

Application 4: Space heating + water heating/A2A cooling

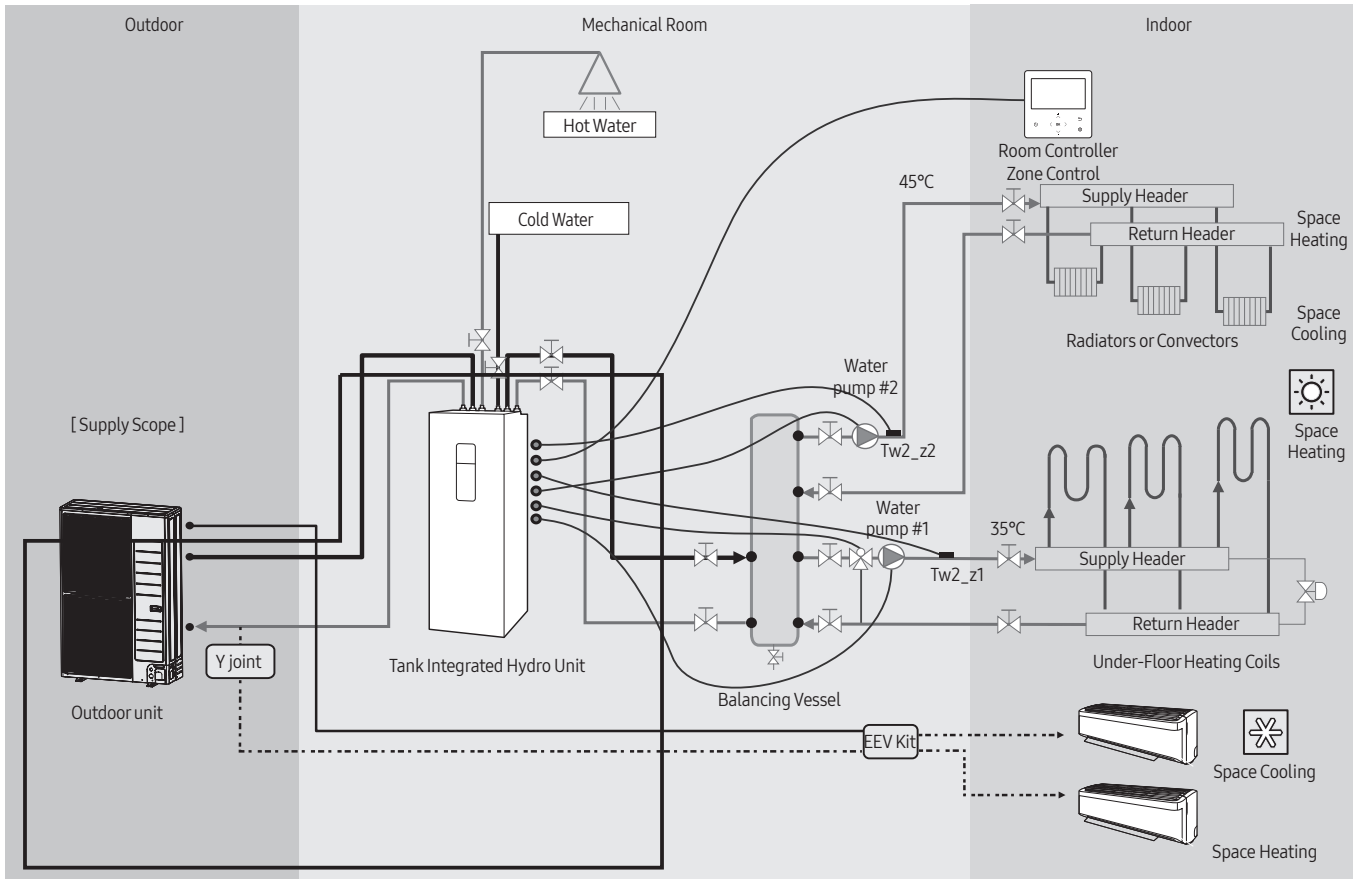

Notes

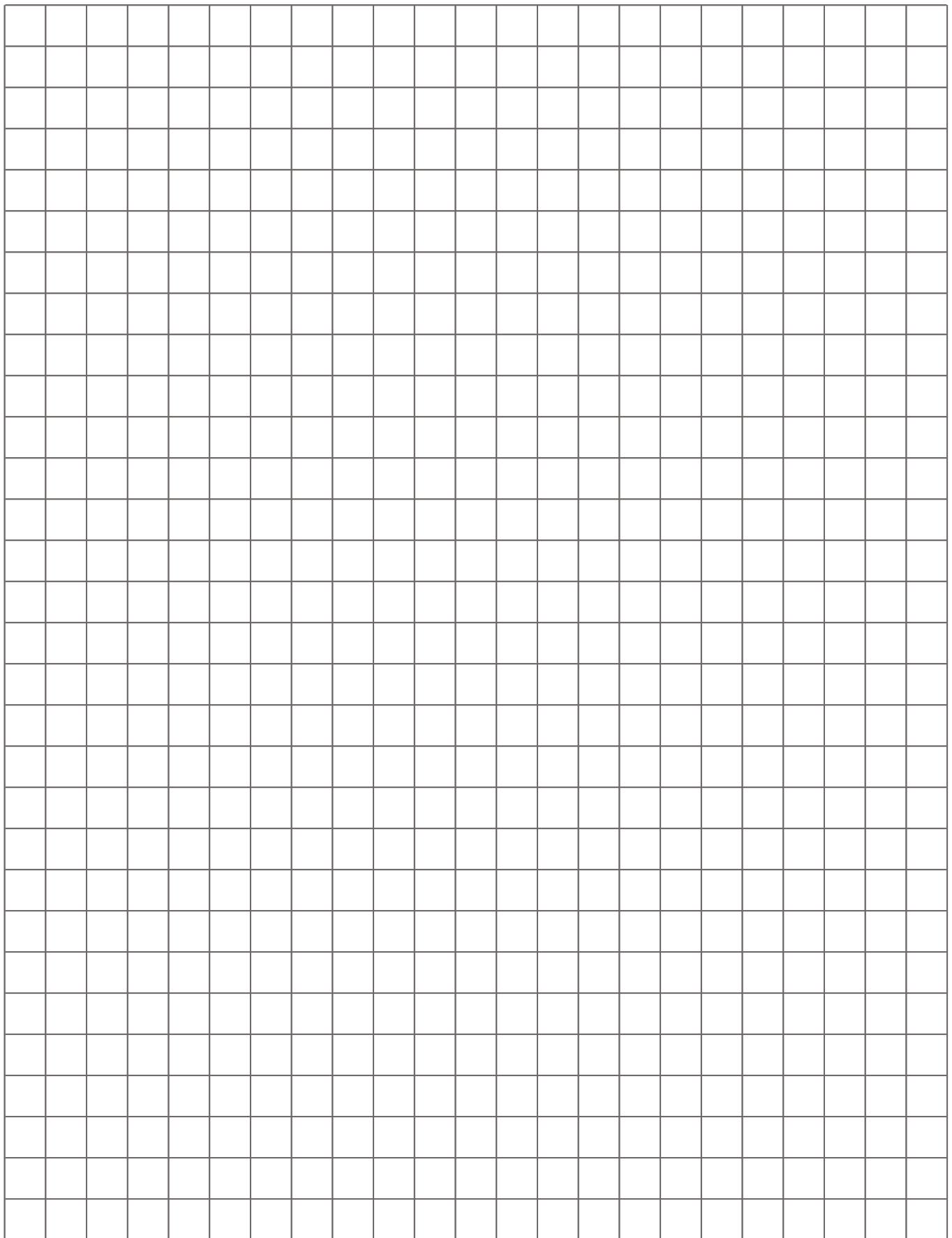

Notes

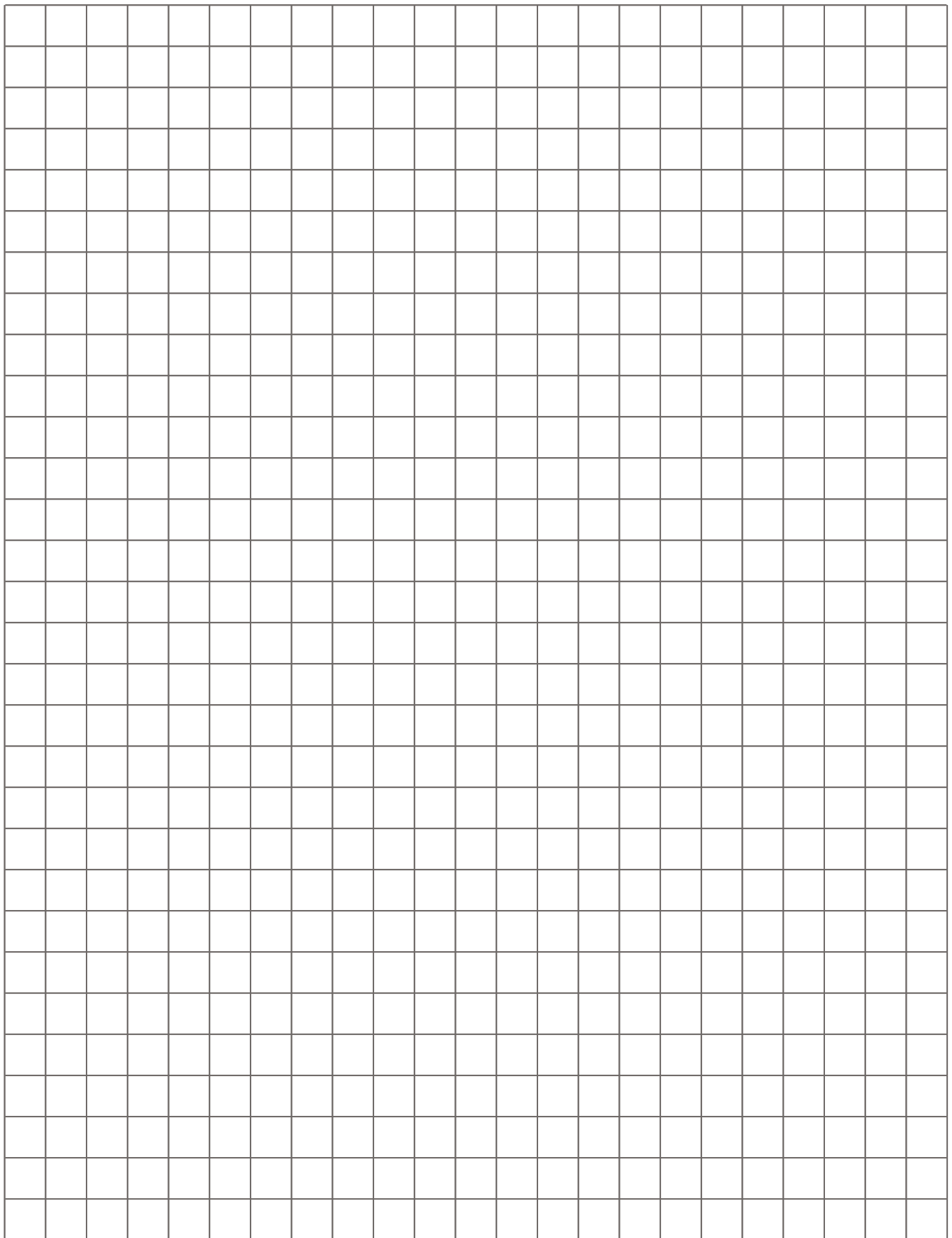

Notes

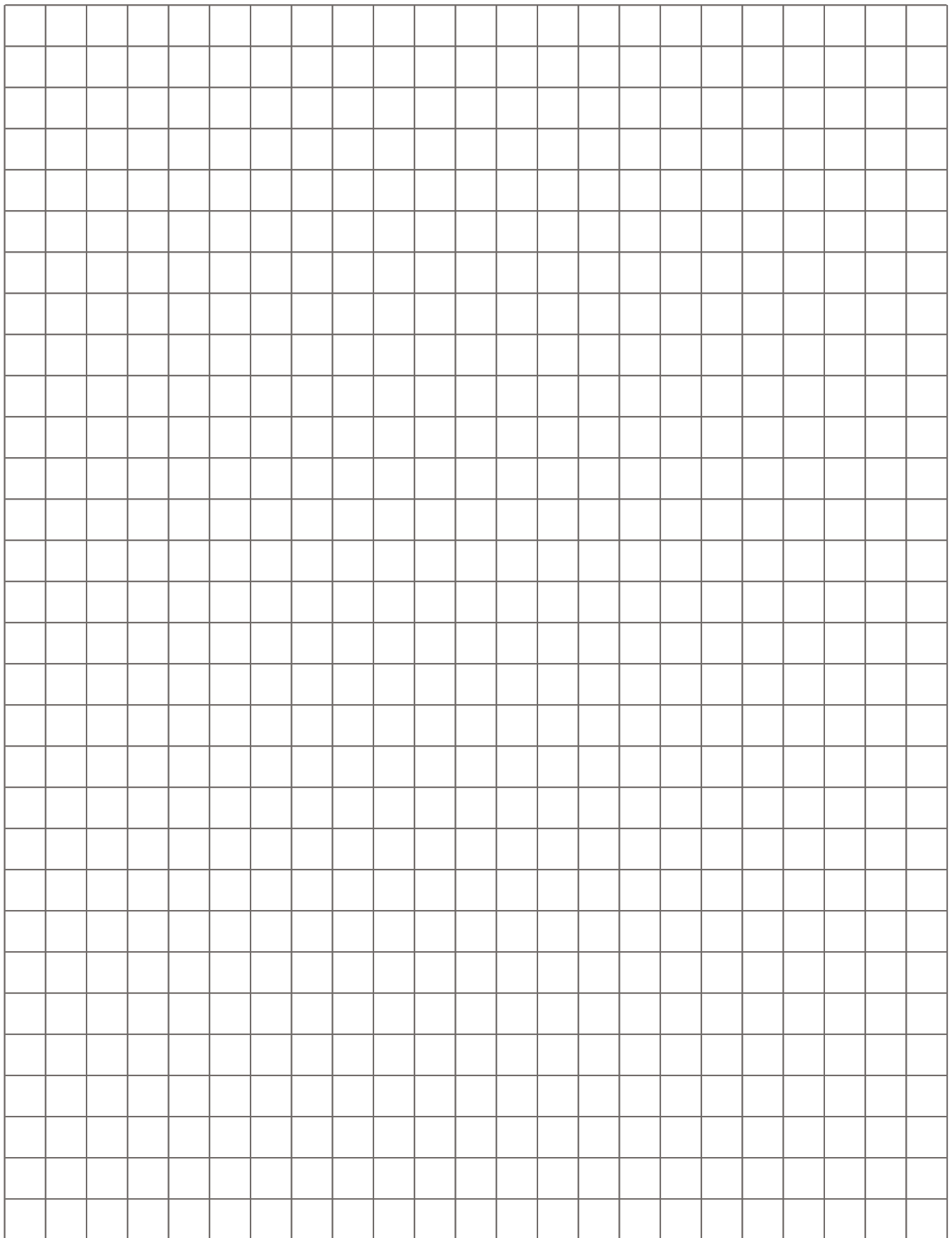

SAMSUNG

Find your flow.

Create your perfect environment.

Learn more about Samsung Climate Solutions at:
www.samsung.com/climate

Copyright © 2022 Samsung Electronics Air Conditioner Europe B.V. All rights reserved. Samsung is a registered trademark of Samsung Electronics Co., Ltd. Specifications and designs are subject to change without notice and may include preliminary information. Non-metric weights and measurements are approximate. All data was deemed correct at the time of creation. Samsung is not liable for errors or omissions. Some images may be digitally altered. All brand, product, service names and logos are trademarks and/or registered trademarks of their respective owners and are hereby recognised and acknowledged.



Samsung Electronics Co., Ltd. participates in the Eurovent Certification Programme (ECP) for Air Conditioners (AC), Variable Refrigerant Flow (VRF) and Liquid Chilling Packages Heat Pump (LCP-HP). To check the ongoing validity of certification, please visit: www.eurovent-certification.com

Samsung Electronics Air Conditioner Europe B.V.
Evert van de Beekstraat 310, 1118 CX Schiphol
P.O. Box 75810, 1118 ZZ Schiphol
+31 (0)8 81 41 61 00
The Netherlands